

UTR -3/1
THE URKESH TYPOLOGICAL RECORD
draft series 3/1

MARILYN KELLY-BUCCELLATI

CERAMICS
FROM THE ROYAL PALACE AK
-1
Part One. The Early Strata

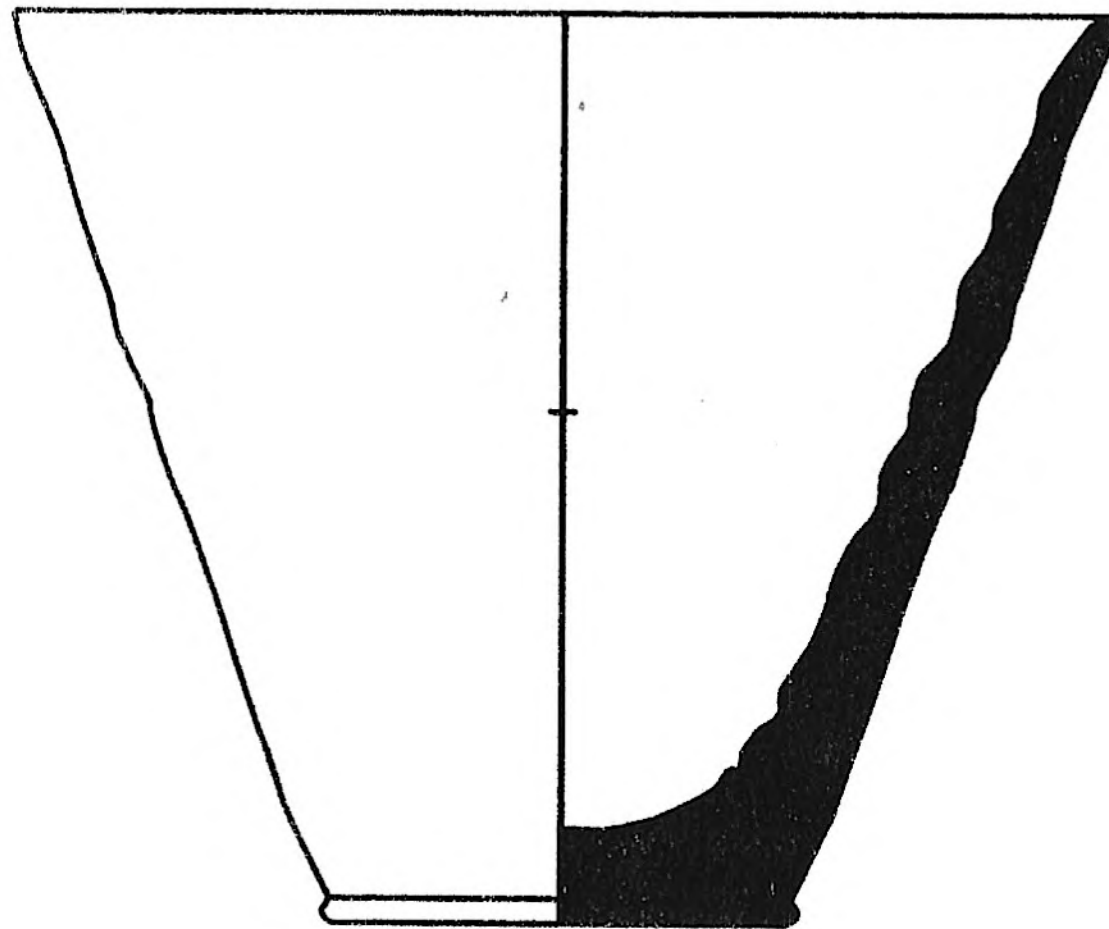

A1.232

July 1997

[see bookmarks for a full Table of Contents]

PART ONE. WARES

Title page

Introduction

3rd Mill. from

AK

ware CH

ware FC

ware WS

ware I

ware IM

ware M

ware FP

ware CP

ware BC

ware ETC

MKB:H6

MOZAN/URKESH WARE DESCRIPTIONS

Introduction

For the 1997 field season (Mozaan 10) it was decided to concentrate on processing the ceramic material from the earliest strata in the AK building. The present catalog is the result of this strategy decision; it reflects the main wares and ceramic shapes only from the earliest strata. A more complete catalog of shapes was prepared in May 1997, *Ceramics from the Royal Palace AK: Seasons 1990-1996*. The basic ware descriptions had been made and refined before the 1992 season and are found in *Mozaan Ceramics: the Third through the Fifth Season*. A further refinement, on the basis of the material from the AK building, is included here. Drawings of the A1 and A5 examples along with drawings of the shape types from A6-8 are found in the shape catalog prepared for MZ 10. This present catalog covers only the strata of the Simple Ware Tradition as excavated in the AK building and not the later Bitumen Use Tradition or Habur Tradition. There is some overlap however especially in the Chaff Tempered pottery and the Fine Chaff wares. It may be that the ceramic inventory is more varied in the later Bitumen Use Tradition in these two wares but that has to be further studied. While there are very few ETC sherds from stratified contexts, there are enough to indicate continuous contact with the mountainous region in eastern Anatolia where this pottery is made. Also relatively rare are sherds and vessels made of Metallic ware. In all mid to late third millennium strata there are always a few sherds of this ware, but the greatest amount has come from the disturbed tombs in the Outer City (Os11 and Os12) possibly indicating that strata with much more of this pottery do occur at Mozaan. Relatively little of this pottery came from temple BA and even less from the AK building and the storeroom in F1. Since the manufacture and distribution of this pottery centers more on the western portion of the Khabur region and the Upper Balikh, Mozaan is on the periphery of this distribution and does not have major concentrations of Metallic ware. Again, as in ETC ware, there is a continuous contact with these western centers but in the case of Metallic ware the contact is greater as reflected in the greater number of Metallic ware vessels present on the site in general and specifically in the AK building. With manufacturing centers farther to the west, the presence of Imitation Metallic ware both at Mozaan and Brak can be understood as an attempt to reproduce the same effect but with a different technology.

Also included in the Simple Ware Tradition is the pottery found in Temple BA. Because of this, many of the shape types given here as examples come from those strata. In general the earlier Simple ware ceramics as found in BA are more refined technically than in the AK building. The AK building however has a wider inventory of shape types. This must reflect the functional difference between these two buildings as well as the chronological difference which is about 200 years. A

small percentage of the ceramics from the AK building are made of a paste as fine or have a shape as well formed or are as uniformly well fired as the typical ceramics from BA. Even given this evidence, it is clear that the main strata in AK were still within this tradition. Drawings of examples from the temple BA and other related strata are found in an unpublished manuscript of MKB.

The distribution of third millennium ceramics in northern Syria and the cultural and possible political realities thereby reflected can only be done after the third millennium ceramics from Brak are published. However a first attempt at synthesis on the basis of the Mozan material can be made. Just before the middle of the millennium Khabur ware was being manufactured in the west and Ninevite V ware in the east. At Mozan both early Metallic ware and late Ninevite V ware are present in the Ob1 and Oa4 tombs. In the middle centuries of the third millennium Simple ware is a more uniform technology and more widespread than any ceramic tradition which is seen later. Metallic ware in the western Khabur is imported in Mozan and not part of the main ceramic tradition at the site. In this period the ceramic tradition at Mozan is centered on a continuation of the Simple ware tradition although with a ceramic standard which is ^{some what} lower in technical achievement. The strength of this tradition locally is evidenced by its continuation in the Bitumen Use Tradition at the site during the latest part of the millennium and probably the earliest part of the second millennium. The continuity of this tradition is impressive, ~~and it without a break.~~ On the basis of the sphragistic evidence it appears that Urkesh, during the later third millennium was a separate political and cultural entity than Brak (probably Nagar in this period). How widespread geographically the kingdom of Urkesh is remains to be determined as well as the chronological limits of its existence.

In the first section of this catalog a description of the wares is presented according to an overall type classification and then the specific variety within the type. The main type classes as included here are: Chaff Tempered, Fine Buff, Metallic, Painted, Early Transcaucasian, Pebble Tempered, Rough. The second section is a shape catalog. This shape catalog is organized by ware and then divided by closed forms to open forms (jars, cups, bowls). The first part of this shape catalog is an index to the rest of the catalog. For more information see: Ceramics from the Royal Palace AK: Seasons 1990-1996. Work on these sherds has involved many people. Helene Cooper processed many of the sherds presented here; William R. Shelby was responsible for the analysis during the eighth season. Most of the drawings in this catalog were made and inked by Alice Frigerio. The Index was produced on Photoshop by Diep Shoemaker.

Group: Mozan Third Millennium Wares from the Early Strata of the AK Building

Type: Chaff Tempered

Ware (Variety)

Chaff Tempered

Basis for Definition: excavated in all areas of the third millennium stratigraphy.

Identifying Attributes: much organic temper on exterior and interior, medium fired, some examples have signs of secondary burning. Vessels are large to medium jars and bowls.

Paste color: orange buff to red

Temper: large amounts of organic temper some small mineral temper

Firing: medium

Firing cloud: none

Carbon core: none

Wall Thickness: 1-2 cm

Forms:

hole mouth jars which can have a triangular tab at rim (MZ2B1q70-1); size range: rim d ca 10-25 cm

jars with simple rim (M1 130; MZ4S1q35-1; A1q500-p1); size range: rim d ca 16-35cm

squared rim jars which can have an exterior lug (A8q94-p3); size range: rim d ca 25 cm

necked jars (A1q51-p1); size range: rim d 10-22 cm

angled rim jars (A5q500-p1); size range: rim d 20-30 cm

straight sided jars (A5q605-p1); size range: rim d ca 20cm

jars with interior ledge (A5q494-p3); size range: rim d ca 20 cm

collared rim jar (A8q87-p2); size range: rim d ca 25cm

large deep bowls (MZ5B4q224); size range: rim d ca 30-50 cm

straight sided deep bowls, some with interior lugs (A1q570-p1); size range: rim d ca 25-30 cm

deep bowls with slightly carinated bodies (A5q645); size range: rim d ca 18-30 cm

deep carinated bowls (MZ4Os12q5; A5q365-p1); size range: rim d ca 18-30 cm

flat rim bowls (A1q835-p4); size range: rim d ca 25-35 cm

platters (MZ4K1q200-1; A5903-p3); size range: h ca 5-7cm; rim d ca 30-70cm

flat bowls (MZ5B5f35+); size range: rim d ca 25-35cm

Surface Treatment: rough to wet smoothed

Burnished: no

Polished: no

Decoration: no

Comments: This ware is very common in all the third millennium stratigraphy; it is, along with Wet Smooth, the ware that is used most frequently for the manufacture of large jars and bowls. It is made from a paste similar to Wet Smoothed ware except that some jar and bowl shapes are different. Also the surface is coarser in this Chaff Tempered category because these vessels have not been as finely smoothed and have more chaff holes on the surface.

Ware (Variety)

Fine Chaff Ware

Basis for Definition: Strata B10-12 in the AK Building

Identifying Attributes: Small amount of chaff and small white gypsum pebbles on the surface, some with strong wheel marks on the interior, especially in the conical cups. The interior of the bowls in this ware are somewhat smoothed but the exterior has evident wheel patterns.

Paste Color: Buff to Brick-Orange. In some conical cups most of the vessel exterior is darker orange but becomes orange-buff near the rim; in these examples the interior is a single color.

Temper: Chaff finely chapped (short stubby forms), small pebbles of white gypsum which appear in section but also on the surface, large amounts of haemetite in the clay of some examples.

Firing: medium to high

Firing Cloud: sometimes on the exterior of small shapes such as conical cups

Carbon Core: none

Wall Thickness: 3-7 cm

Forms:

narrow necked bottles (A5q945-p1); size range: rim d ca 5 cm

wide spouts (vessel form undetermined); size range: wall thickness ca 5-6

mm

necked jars (A1q928-p3); size range: rim d ca 8-12 cm

conical cups in this ware are in three basic shapes:

1) (A1.78; A1.232; A1q65); size range: h ca 7-10 cm, rim d ca 10-14 cm

2) rougher cups many of which are poorly shaped on the wheel, string cut bases, with some tempering, especially sand, strong wheel marks on the exterior (MZ3B1.166); size range: h ca 8cm; rim d ca 9cm

3) same as no. 2 but in a taller cup (MZ3B1.130); size range: h ca 9-12 cm, base d ca 4cm.

straight sided deep bowls (A1q931-p1; A1.62-p1); size range: rim d 8-12 cm

deep bowls, some carinated (A1q931-p3); size range: 6-10 cm

rounded profile bowls (A5q922); size range: h ca 4-6cm; rim d 12-15 cm

carinated bowls (A5q45-p1); size range: rim d 18-25 cm

bowls with interior thickened rim (A5q902-p1); size range: 18-25 cm

flat rim plates (A5q680-p4); size range: rim d 12-25 cm

Comments: The coarser conical cups were categorized in Temple BA as either Simple ware or a conical cup ware; it is only with the AK building that these coarser conical cups were reclassified into FC ware.

Type: Fine Buff Wares

in the AK bldg the ceramics of this ware have a high percentage of gypsum

General Description: All the wares in this type are characterized by being made of a fine buff paste which fires to a green to yellow buff. All are high fired with little mineral or organic temper; none have a firing cloud; none have a carbon core. The medium and large vessels made of this paste have more temper, and are thicker walled. None have been burnished but some surfaces of early examples have a deep, regular vertical pattern which is clearly a decoration (S1.57).



Ware (Variety):

Simple

Basis for Definition: excavated near city wall K1 and S1, temple BA, Tomb in Oa4, the AK building strata AKsB10-12, storeroom in F1, also found in abundance on the surface of both the High Mound and the Outer City.

Identifying Attributes: Little or no temper, high firing, uniform buff to green-buff color, conical cups and small bowls, spouted pots, string cut, flat, and slightly convex bases some cups have low footed bases. A group of conical cups are made in a rougher version of this ware with gypsum temper and even some gypsum pebbles appearing on the surface categorized as Fine Chaff ware and discussed separately.

Paste color: buff to greenish buff

Temper: some vessels have no temper while the coarser examples of the conical cups have some sand temper, some vessels can have small to medium white gypsum pebbles showing on the exterior

Firing: highly fired

Firing Cloud: none, but in many of the cups and bowls there is a change in color on the exterior from the body of the vessel to the vessel wall near the rim with the latter being lighter in color

Wall Thickness: from ca 3 to 5 mm

Forms: This is the most common type of pottery for small and medium cups and bowls in ED III and Akkadian periods.

small jars with S-curved profile (A5q640-p1); size range: rim d ca 4-8 cm

small jar with outturned rim, rounded base (MZ6 A1q58); size range: h ca 6-10, d ca 4-8

high necked jars (A5q793-p1); size range: rim d ca 5 cm

conical cups are found on Mozan\Urkesh in three basic shape types of which two are in the related FC ware:

1) shorter cups with a slight widening of the body just before the reamed base (MZ4Os11.13); size range: h ca 5-8cm; rim d ca 13cm

2) rougher cups in FC ware many of which are poorly shaped on the wheel, string cut bases, with some tempering, especially sand, strong wheel marks on the exterior (MZ3B1.166); size range: h ca 8cm; rim d ca 9cm

3) same as no. 2 but in a taller cup (MZ3B1.130); size range: h ca 9-12 cm, base d ca 4cm.

deep bowls, some necked (A1q928-p1), hole mouth (A1q436-p1), straight sided (A5q516-p1); size range: rim d 5-18 cm

carinated bowls (A1q897-p1); size range: rim d ca 20 cm



simple bowls (A1q1044-p1; A4q705-p3); size range: h ca 4 cm, rim d ca 7-22 cm

large bowls with flat or slightly concave bases; bases can have a groove around the exterior or a reamed edge as a transition from the body to the base (MZ3B3.47); size range: h ca 9.5; rim d ca 19

small rounded bowls with rounded or convex bases (MZ3B3.26, MZ5B5.54); size range: h ca 6.5; rim d ca 12

small straight sided bowl with flat base (MZ5B5.39) size range: h ca 4-7cm; d ca 8-10cm

Other shapes: footed cup (M1 16); size range: h ca 8, d ca 6-10cm, base 3-4cm

spouted vessels (MZ3B3.44, MZ5B5.42); size range: h ca 7-9cm; rim d ca 5-7cm; shape range of vessels unknown

Manufacturing Techniques: strong wheel marks on the exterior of some conical cups and bowls; very high quality ware in most of the vessels made from it.

Surface Treatment: self slip

Distribution: most common type of pottery for small and medium- small sized vessels in all excavation units dating from ca 2400 to 2200 BC.

Comparative material: spread throughout northern Syria; also found in parts of eastern Anatolia.

Comments: conical cups range in quality from the fine (Paste Category 1), well made examples to very coarse examples (Paste Categories 3a and 4). One group from the temple is so fine that they are characterized by their smooth surface which appears to have been slightly polished, this untempered subtype is called at Mozan Stone ware (it occurs in sherds from the temple and in a bowl MZ3B1.184 which was found in the same deposit as the lion statue, near the statue). This type of ware must have been only manufactured mid third millennium because it is mostly found in the temple BA and associated strata; some sherds are associated with the earliest strata of the AK building. In later third millennium strata the pottery making tradition was not as refined and pottery probably could not duplicate such a high quality product.

Conical cups were very common in the temple BA and in the AK building with the chronological distinction being that in the temple these cups were made predominantly in the finer Simple ware and in the AK building they were made in the coarser FC ware. This distinction holds true in the MZ9 excavations in the AK building entrance (A7). Most conical cups have string cut bases but many manufactured in Simple ware have reamed bases with a very sharp break between the body wall and the flat base (eg. A5q838-p1). In neither the temple BA nor the AK building were the tall form of these cups common. Also the type of conical cup with a slight flaring before the base (in FC ware A1q1038-p1) is not common in either of these two excavations. Some conical cups were reused, after being broken, as lamps evidenced, by the burning pattern inside and over the broken section.

The conical cups have a very standard shape and size range. The shapes include tall cups (rarer), standard cups, and cups which instead of tapering directly

from the rim to the base, are slightly rounded before the base. Most bases are string cut ranging in size in FC ware from 3.5 cm to 4.6 cm; a 4 cm base is most common. The taller cups in FC ware have a base size from 5.2 to 6.2 cm. In Simple ware the string cut bases range in diameter from 4.3 to 4.6 cm, slightly larger than the bases in FC ware. Taller conical cups made in S ware have a base diameter from 4.8 to 5.2 cm.

In seasons 1-6 seasons thin shapes of Wet Smoothed ware were separated from this Simple ware variety. After the 1991 study by Dr. Marilyn Beaudry-Corbett these finer Wet Smoothed examples were added to the Simple ware variety (that is beginning with the 7th season, 1992).

Ware (Variety):

Wet Smoothed

Basis for Definition: excavated in all third millennium strata, especially mid and late third millennium contexts but also including some early third millennium material. This is the most common type of pottery for medium size vessels; some larger jars are also made in this ware.

Identifying Attributes: buff to yellow buff in color, paste appears to be the same as Simple ware but this ware is used for larger shapes of jars and bowls and has tempering in it; usually medium fired. The smooth surface finish is a very important distinguishing characteristic of this ware since its paste characteristics are the same as the Chaff Tempered ware.

Paste color: buff to yellow buff (10YR 8/2 to 5y 8/2 white)

Temper: can have very small amounts of chaff temper, mineral temper size can vary from large pebbles to fine sand, density is medium

Firing: medium

Wall thickness: varies with size of the vessel but usually from 5 to 10 mm

Forms:

In the early part of the third millennium stands with cut out designs from Ob1 (MZ3Ob1.61); size range: h ca 18cm; rim d ca 19cm.

narrow necked jar or bottle (A5q680-p5); size range: rim d 4-8 cm

jars with interior grooves around the rim; some have potters marks or capacity marks incised at the rim (MZ2K1q118-1, MZ2K1q118-2, MZ2B1q176-1; A5q494-p1); size range: rim d ca 11-34cm

necked jars (A5q680-p1); size range: rim d ca 8-15 cm

collared rim jars (A5q645-p4); size range: rim d ca 12 cm

flaring rim jars (MZ3B3.14; A5q901-p2); size range: h ca 14cm; rim d ca 7-21cm.

small egg shaped jars (F1.129) size range: h ca 13, rim d ca 6

large egg shaped jars (F1.110) size range: h ca 50, rim d ca 16

bulbous rim jar (MZ3B4q106-1); size range: rim d ca 10-25cm.

deep bowls with s-profile (MZ3B4.69; A1q868-p3); size range: h ca 13cm; rim d ca 19cm.

other deep bowls (A5q899-p1); size range: rim d ca 20 cm

*in the AK field
this ware has
a high percentage
of sm. gypsum
in the section*

deep bowls with interior triangular lugs and flat bases (MZ2 B1 q176); size range: d ca 20-30cm.

deep bowl with exterior lugs (B3q47-13)

wide bowls (A1q122-p1); size range: ca 22 cm

Manufacturing Techniques: Some large jars may have the upper portions only made on the wheel.

Surface treatment: Surface is wet smoothed so that all particles on the exterior of the vessel are uniform. There are no traces of the tool used for this so it must have been done when the vessel was quite wet.

Comments: This ware is probably made from the same or very similar clay source as the Ninevite V and Simple wares. It however was used to produce the medium and large bowl and jar shapes which are different from Ninevite V and Simple ware shapes. Unincised portions of Ninevite V Incised vessels may be mixed in with this ware in the sherd counts of the seasons through the sixth since during these years the finer Wet Smoothed sherds were counted separately. This problem is minor since very few Ninevite V vessels have been excavated at Mozan. The undecorated portions of Incised and Rope decorated vessels have often been counted in this category.

Ware (Variety):

Incised and Rope Decorated

Comments: This type existed in the late ED III period continued into the Ur III period. Second millennium examples have different rope patterns and incised designs.

Basis for Definition: Upper floor at top of stairs and shelf in temple BA and the AK building.

Identifying Attributes: green buff, highly fired, incised/rope decoration; ware related to Wet Smooth but separated out because of the decoration. Shapes include large bowls and jars. Bowls have only rope decoration while jars have either only the incised patterns or both incisions and rope decoration. The ware is very similar to WS ware but with the addition of decoration. The shapes are more limited and differ somewhat from WS ware.

Paste color: green buff

Temper: sand temper with some fine chaff

Firing: highly fired

Wall Thickness: 5-10mm

Forms:

large jars (A1q1031); size range: rim d ca 20cm.

large necked jars (A5q926+); size range: rim d ca 22 cm

hole mouth jars (F1q559); size range: rim d ca 13-22 cm.

deep bowl (F1.23, F1.99, MZ3B4q101, A5q152); size range: rim d ca 20-48 cm

small bowl (MZ3B4.56; A1q963-p3); size range: rim d ca 10-18 cm

Surface Treatment: in some cases can be rough and in others surface is wet smoothed

precised with the vessel walls an even thickness and the shapes uniform; the heavy wheel marks are gone. This pottery has a mass produced look of a very high quality product.

Burnished: sometimes burnishing marks are visible

Polished: a light polish

Comparative Material: see H Kuehne, Die Keramik vom Tell Chuera (1976), excavated sherds from Tell Chuera, and H. Kuehne and G. Schneider, "Neue Untersuchungen zur Metallischen Ware," Damaszener Mitteilungen 3(1988), pp. 83-139 (mostly surface sherds). By this period Metallic ware had spread from northeastern Syria as far south along the Euphrates as Terqa and northward into the Keban area of northeastern Anatolia and westward; see the distribution map in Kuehne.

Comments: Bottles are found both in Metallic ware (the AK building and OS11) and Imitation Metallic ware (the AK building and F1).

Ware (Variety):

Imitation Metallic

Basis for Definition: surface, temple BA, storage room in F1, the AK building; there are few examples of this ceramic variety in the Mozan corpus but these examples increase in the AK building and in the slightly later F1 storeroom.

Identifying Attributes: coarser exterior surface than Metallic ware, paste not as fine as Metallic ware, painted portions on the neck and body in dark brown to red-brown color so that it appears to be same color as Metallic ware, shapes can be similar to Metallic ware but more varied than our inventory of the ware, more temper than Metallic ware and not as highly fired.

Paste color: red-buff; the exterior is often dark gray-brown because of the paint

Temper: some organic and small to medium mineral temper

Firing: medium

Firing cloud: one sherd from A1 f137 may have a firing cloud

Carbon core: none

Wall Thickness: near the rim of jars ca 4 cm, near the base ca 5-6 cm

Forms:

bottles (A1q928; F1.114; the F1 example has three tiny feet, spouted) necked jars, flat and rounded bases

Manufacturing Techniques: wheelmade with thick paint applied to the exterior.

Surface Treatment: painted to look like Metallic ware, surface wet smoothed and rougher than Metallic ware.

Burnished: no

Polished: no

Decoration: no (paint on exterior not meant as a decoration (and is not applied in any design pattern) but to make vessel appear like Metallic ware.)

Comparative material: some at Brak (personal communication from Joan Oates).

Decoration: placed below rim, can have incised lines, rope decoration or both. Incisions are in parallel horizontal bands either plain or wavy. Often the wavy bands are bordered on the top and bottom with bands of horizontal incised lines. A single band of rope decoration with parallel straight incised bands on the top and bottom is most common while just a single rope decorated band does occur, especially on large deep bowls; it is placed lower on the body of the vessel than the incised decoration.

Comments: On parts of the vessel bodies which are not decorated this ware may be confused with Wet Smoothed or, in the case of very well fired examples, a ware which is predominantly second millennium but which begins at the end of the third millennium (GBH). Rope decoration alone occurs in most time periods excavated thus far at Mozan. A narrow rope band was applied to a small vessel from the Ninevite V period, rope bands occurred on Wet Smoothed vessels in f16 of K1, temple BA and the AK building. During the Nuzi period rope decorated bands are very common; they are often found in more than one band applied to the body of the vessel near the rim.

TYPE: Metallic

Ware (Variety):

Later Metallic

Basis for Definition: surface sherds and vessels, few sherds in temple BA and the AK building, greatest amount near the disturbed burials in Outer City (Os11 and Os12)

Identifying Attributes: Fineness of paste, color grey or orange, highly fired, necked jars, medium bowls

Paste color: grey, or orange, sometimes orange-brown but most vessels are gray with a more uniform color than the early variety of this ware.

Temper: very little (sand or at times large white pebbles on the surface)

Firing: very highly fired

Wall Thickness: ca 3mm-1cm

Forms

bottles (MZ4OS11surface, MZ8A1q943); size range: rim d 8 cm

necked jars with rounded bases (A1q153, MZ3OZ1.27); size range: rim d ca 7-15 cm.

small jar (A5q841-p1); size range: rim d ca 8-10 cm

medium jars (MZ5B5 f55+), size range: rim d ca 16

medium and small rounded bowls (M1 119; MZ4OS11; A1q840-p7); size range: rim d ca 10-20 cm.

medium and small straight sided bowls (MZ4OS11), size range d ca 10-18 cm

rounded, low footed, and small ring bases

Manufacturing Techniques: the firing control has been perfected so firing errors seen in the earlier variety are corrected, also control of the form is more

Identifying Attributes: open vessels with interior plastered with white or plum colored plaster. Many vessels from K1 f16 are large jars or vats with very little curvature shown in some body sherds. Signs of a liquid which has dripped down the exterior is frequent.

Paste color: buff-red

Temper: organic with some sherd temper

Firing: examples found in K1 f16 were well fired but this may be due to the fact they came from a storehouse which had burnt down, probably originally they were medium fired. In some examples the interior plaster was burnt to a bright orange red by the destruction fire.

Firing cloud: none

Carbon core: yes

Wall Thickness: in larger vessels 2.5 cm thick; thinner vessels are ca 1.3 cm thick

Forms:

jars with outturned rims (MZ5B5f55+); size range: large rim d ca 48-70 cm

deep bowls with squared rims (can have interior oval lugs eg. MZ4K1 q215-1, A5 q400-p1); size range: rim d 25 cm and larger

deep bowls with outturned rim (A5q852-p1); size range: rim d ca 60

vats (?) (MZ4K1q215-2); size range: rim d ca 80cm

The thinner shapes have more curvature in the body walls so were probably of somewhat smaller jars. Both flat and rounded bases are preserved.

Manufacturing Techniques: Slab made and constructed in layers which can be seen in section; cracks from the drying process can also be seen on the exterior. In some cases the lower body wall is much thicker than the base, as much as 8mm difference. The exterior surface was left rough without any wet smoothing in the manufacturing process. The interior is plastered.

Surface Treatment: left rough

Burnished: no

Polished: no

Decoration: no

Comments: In K1 f16 the majority of these sherds were found. They came from a burnt building so that all the vessels were secondarily fired. Some vessels had the plum red color on the interior plaster and also dripped down part of the exterior of the vessel. This is not uniform and more than likely was the result of later use rather than part of the manufacturing process. A few of these sherds were found in temple BA and the AK building.

temper is very low.

Burnished: yes but not carefully done

Polished: no

Decoration: no

Distribution: temple BA and the AK building; in most third millennium strata from the site.

Comparative Material: Harran

Comments: This ware was the principal third millennium cooking ware at Mozan. Many sherds are secondarily fired and appear to have been fired repeatedly making the vessels very friable. Some had been secondarily fired so many times that the sherds broke apart on washing.

Ware (Variety):

Fine Pebble Tempered

Basis for Definition: temple BA and the AK building

Identifying Attributes: Many small pebbles used as temper, these can be seen in section and on the surface, very friable, surface dark brown to black and burnished.

Paste color: dark brown

Temper: many pebbles, very little organic temper

Firing: low to medium fired

Firing cloud: none

Carbon core: yes

Wall Thickness: ca 2mm

Forms: all small

small hole mouth jars (MZ3B4q48-2); size range: rim d ca 10-20cm.

small jars (MZ4S1q32-1, A1q963-p1); size range: rim d ca 8-10 cm

small bowls (MZ3B4q48-1); size range: rim d ca 10-14cm.

deep bowls (A1q840-p2, A1q928-p2); size range: rim d ca 10-15 cm

Manufacturing Techniques: very friable, burnished to compact the surface which otherwise would have little consistency since the proportion of paste to temper is very low.

Burnished: yes, burnishing better done than on the coarse variety

Polished: some vessels may be polished

Decoration: no

Comments: Most of the sherds in this ware give evidence of secondary firing indicating that they probably were also utilized in food preparation although their small size would have restricted their use.

Type: Rough:

Variety Unspecified

Rough

Basis for Definition: K1 f16 burnt deposit outside city wall, some sherds from temple BA, some sherds from the AK building

necked jars (A1q936-p1); size range: rim d ca 10-20 cm
 flat rimmed jar or deep bowl (A1q1000-p1); size range: rim d
 small bowls (M1 40, MZ5B5 f35+); size range: rim d ca 18-20 cm
 medium bowl (MZ5B5f35+, A1q883-p1); size range: rim d ca 18-20
 deep bowl (MZ5B5f35+, A1q878-p2); size range: rim d ca 20-30cm

Manufacturing techniques: contrast between coarse pottery and very highly polished surface

Surface Treatment: very highly polished

Burnished: yes on the poorer examples

Polished: highly polished on most examples

Decoration: no, except see below

Distribution: not many sherds of this ware at Mozan

Comparative material: common throughout eastern Anatolia and into the Caucasus.

Comments: the Mozan examples are only black and grey, we have no orange, red or bicrome examples; the only bicrome example came from the surface (Z1.313). The examples of this pottery probably imported from the Elazig area where there are a large number of varieties in this type not found at Mozan. One very fine surface sherd in a finer variety of this ware was found with small stamped triangles along the interior rim of a small bowl (B1q35, f23). One fine black incised sherd was found in A5q503v.

Type: Pebble Tempered:

Ware (Variety):

Coarse Pebble Tempered

Basis for Definition: temple BA, AK building; this is the standard third millennium cooking pot ware in Urkesh.

Identifying Attributes: many small pebbles used as temper, very friable, highly burnished, exterior; before being used as a cooking vessel its color is brick red but on use becomes dark brown to black.

Paste Color: unused medium brown (5YR 7/4 pink); used dark brown

Temper: many pebbles, small amount of organic temper

Firing: low to medium, most secondarily burnt

Firing Cloud: none

Carbon Core: yes

Wall Thickness: 1-2 cm

Forms:

hole mouth jars (MZ3B4q88-1); size range: rim d ca 19-25 cm

large jars (MZ1B1); size range: rim d ca 30cm

deep bowl with exterior semicircular tabs (MZ4B4q134-1);

size range: rim d ca 30cm but they can be as wide as 60 cm

lid (A1q927-p4)

Manufacturing Techniques: very friable, burnished to compact the surface which otherwise would have little consistency since the proportion of paste to

Type: Painted

Ware (Variety):

Bi-Color

Basis of Definition: Very few examples from the excavations; none found on the surface. The AK building Str B12 (6 sherds incl 5 bowl rims and one body sherd), Str B11 (2 bowl rim sherds). This ware is placed in this type class but it is not clear that it is actually painted; color difference may be from firing. This ware may be associated with Imitation Metallic ware.

Identifying Attributes: Bright Brick Orange exterior and interior (interior usually somewhat duller in color), dark to medium brown at rim and the exterior; this color never extends beyond the rim onto the interior. Exterior smoothed and in some bowls polished.

Color: Exterior and Interior - Brick Orange body with brown portion at the top of the exterior

Paste Color: Gray-green

Temper: Very fine chaff, some small mineral inclusions; on exterior and interior can have some larger pieces of white gypsum

Firing: Wide range in firing temperatures from low to high. In highly fired pieces the section is the same color as the exterior, red-orange; in low fired examples the section is buff. This is especially seen in the one, thicker, body sherd from the AK building, f113.

Firing Cloud: none

Carbon Core: none, but firing low so some change color in section

Wall Thickness: bowls ca 4-5 cm

Forms: Small and medium bowls but the one body sherd from the AK building f113 indicates that larger forms exist. Bases are rounded. Size range: rim d ca 10-25 cm

Type: Early Transcaucasian

Variety Unspecified

Early Transcaucasian

Basis for Definition: surface sherds, sherds found in temple BA (eg B5 features 23 and 35), some from the AK building.

Identifying Attributes: highly polished black or gray? surface, much temper, small and medium bowls, necked jars

Paste color: dark gray (10YR 3/1 very dark gray)

Temper: much organic and small mineral temper

Firing: medium

Firing cloud: none

Carbon core: usual

Wall Thickness: rim d ca 5mm

Forms:

PART TWO. SHAPES

COVER

ware CH

jars

bowls

misc.

ware FC

jars

conical cups

strainers

bowls

ware S

small jars

conical cups

bowls

ware WS

jars

bowls

ware I

jars

bowls

wares M, BC, ETC

wares P, FP, R

AK

A8sA8a

A8s94-p2

CH
SIMPLE RIM
+
SQUARE RIM
JARS

f32

CH

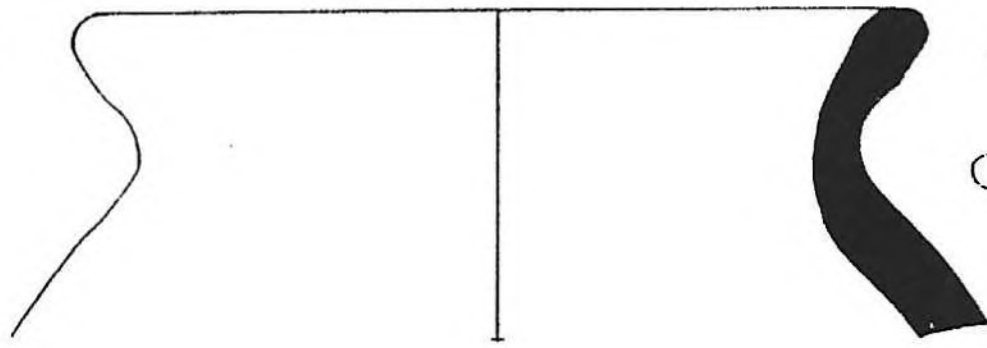

A8sA8

A8s113-p4

f12

CH

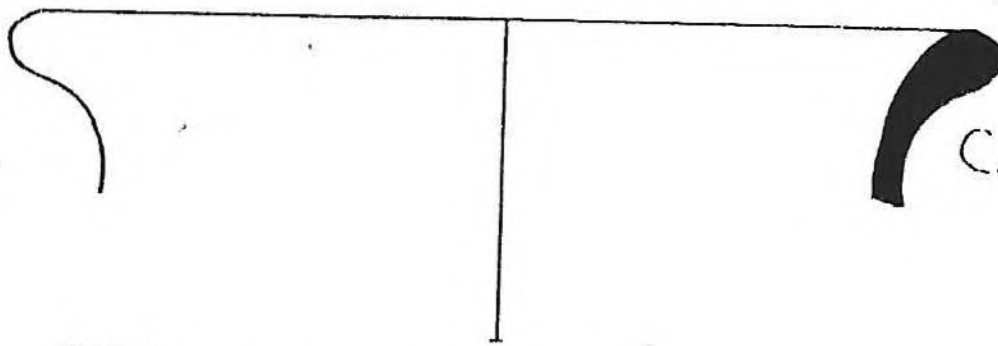

A19500-p1

CH
AKSB11

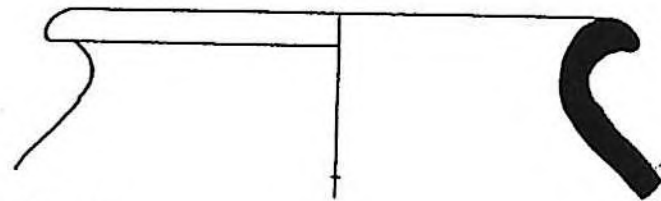

A8sA8a

A8s97-p1 f32

CH
+

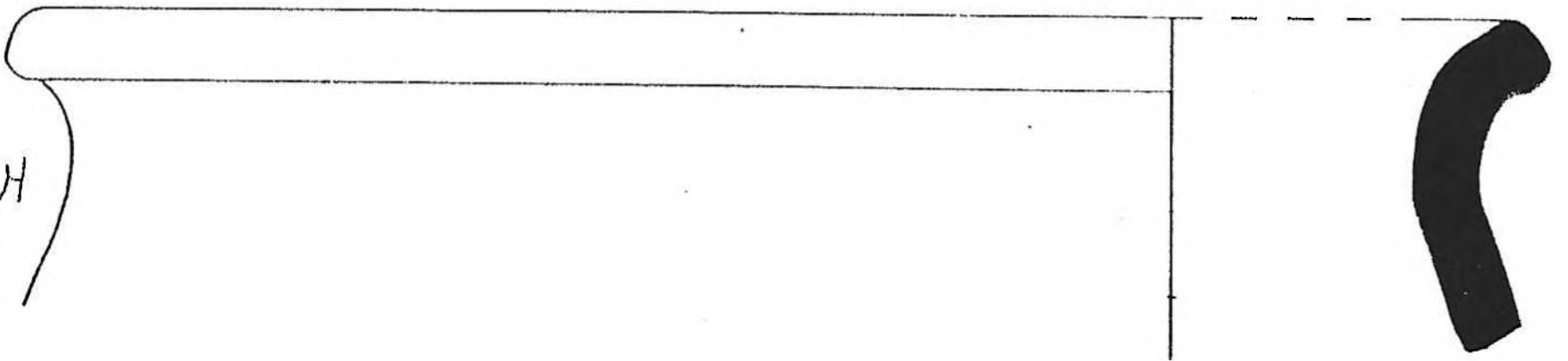

SIMPLE RIM JARS

A8sA8a

A8s94-p3

f32

CH
x

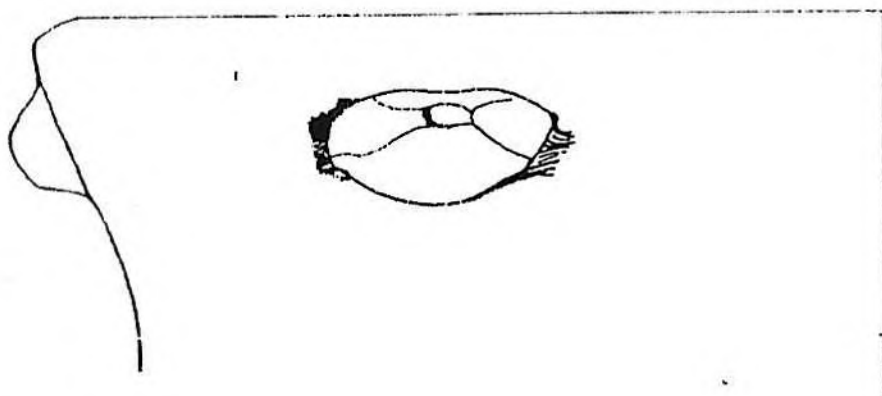

SQUARED

RIM JAR



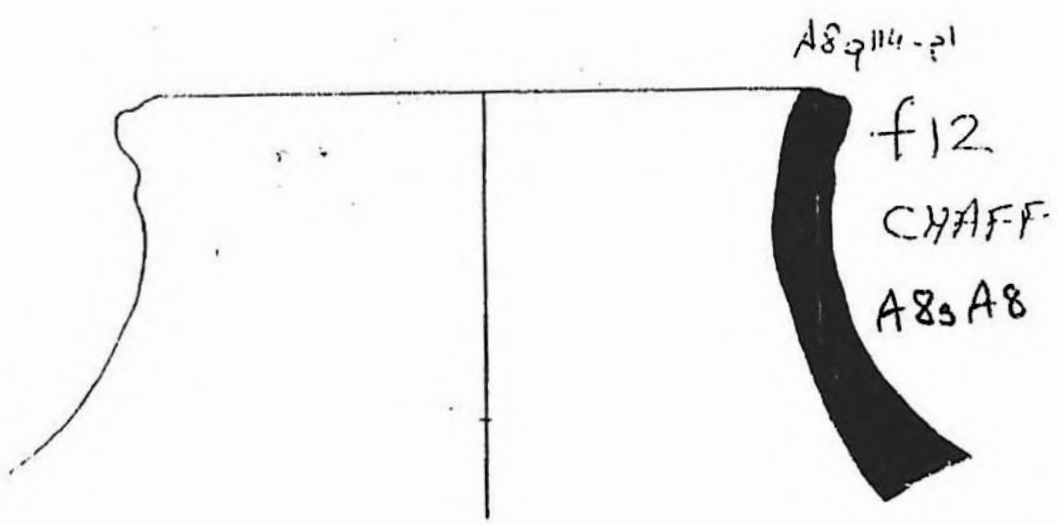

AK

CH
NECKED JARS

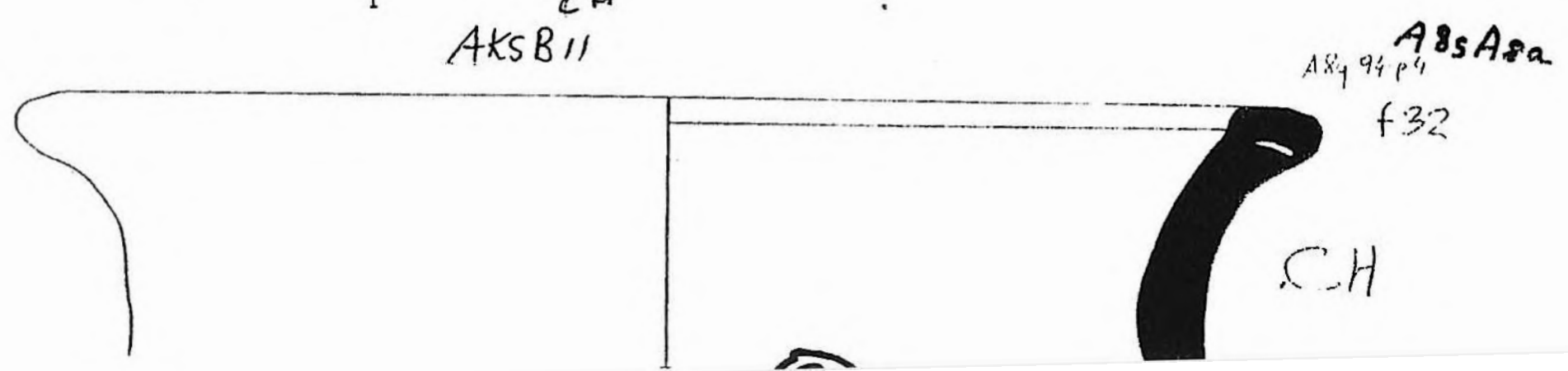
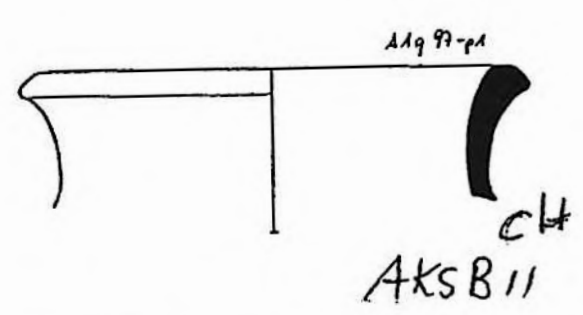
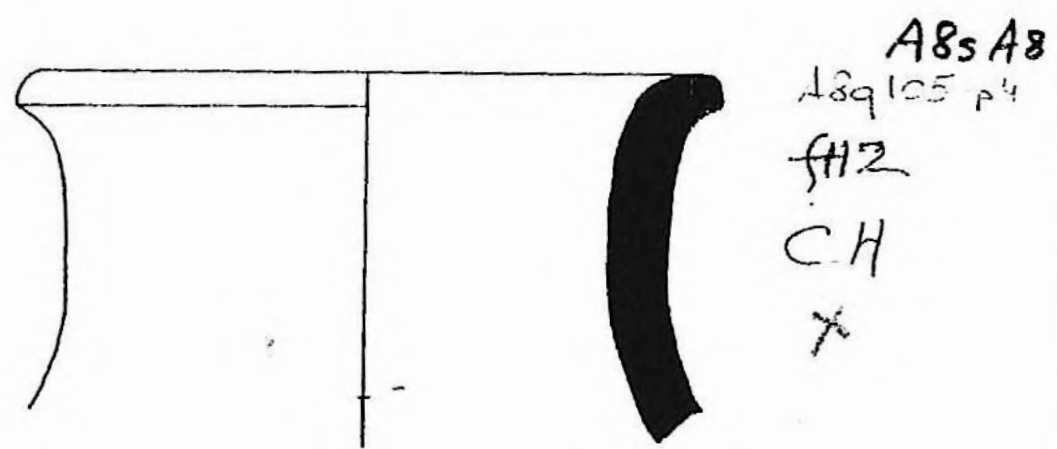
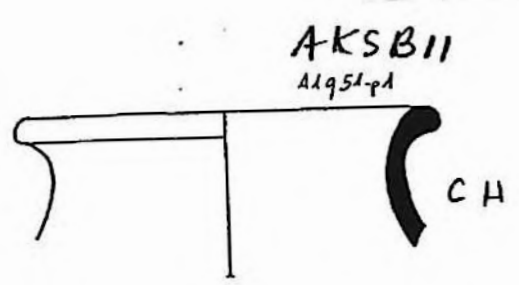
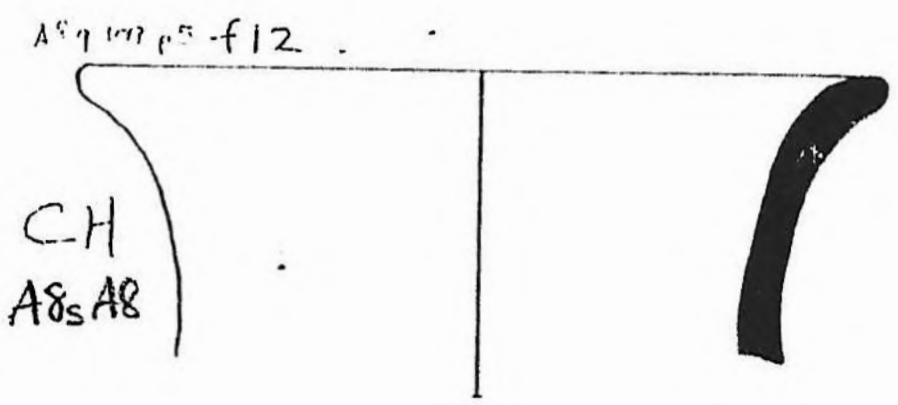
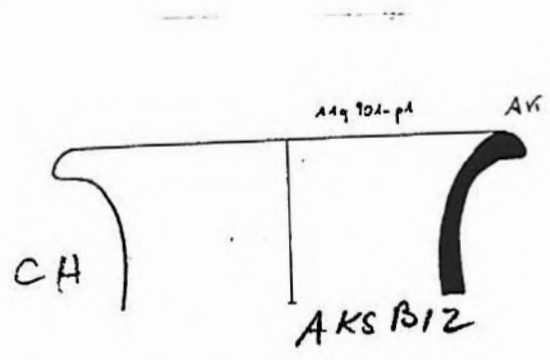
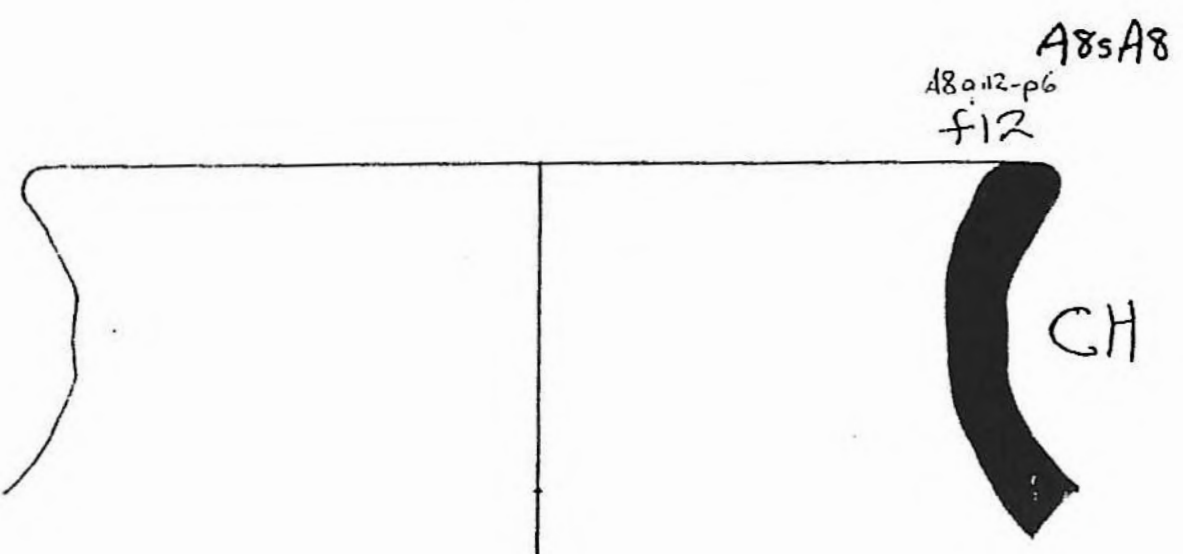

AK

CH

ANGLED
RIM JARS
HOLE MOUTH JAR

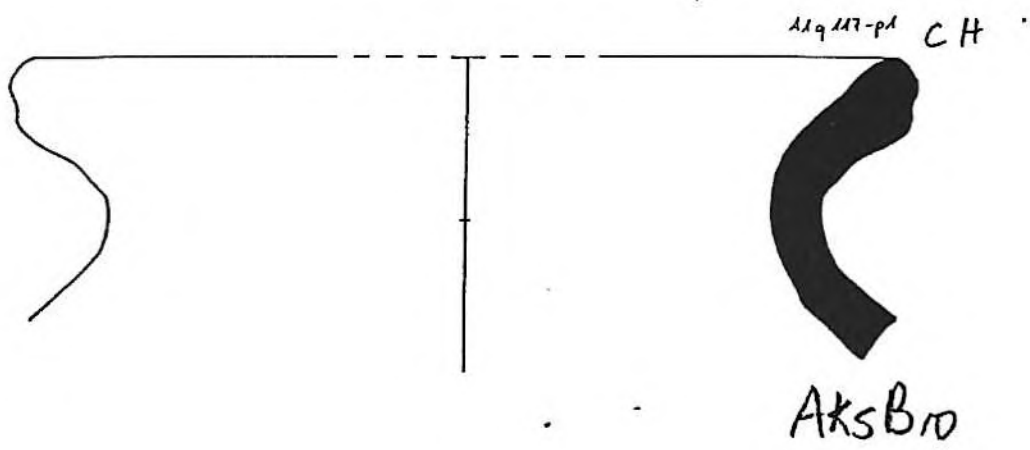
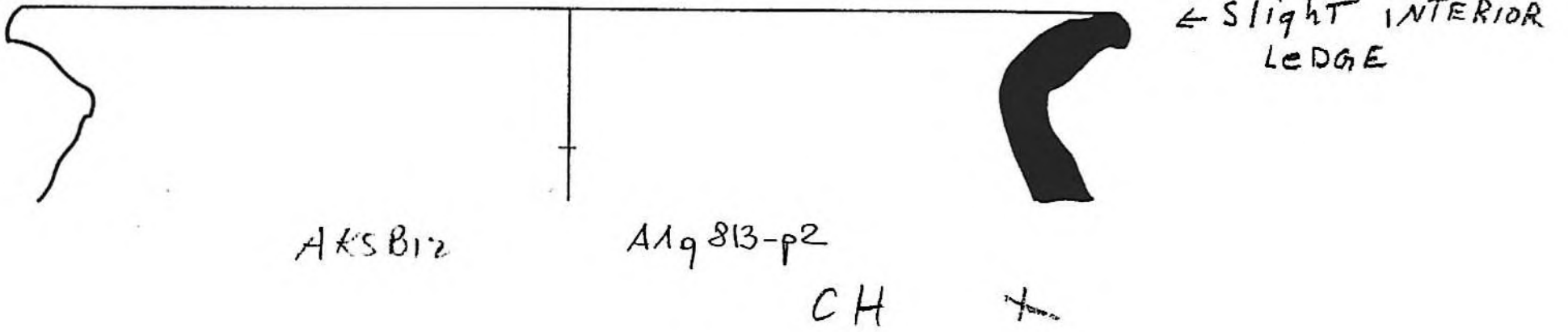

ANGLED RIM JARS

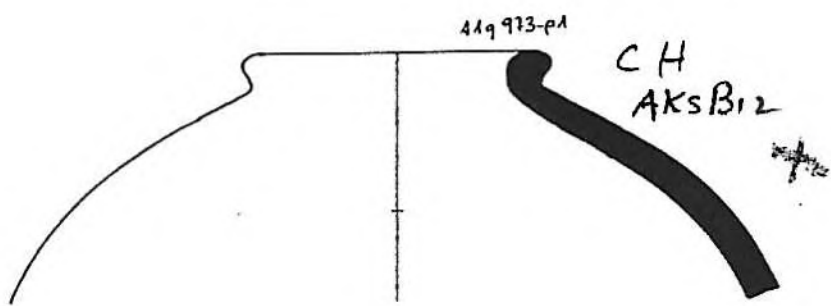

HOLE MOUTH JAR

3

AK

CH
JARS

A85A8a
A8981-p2



f32

CH

*

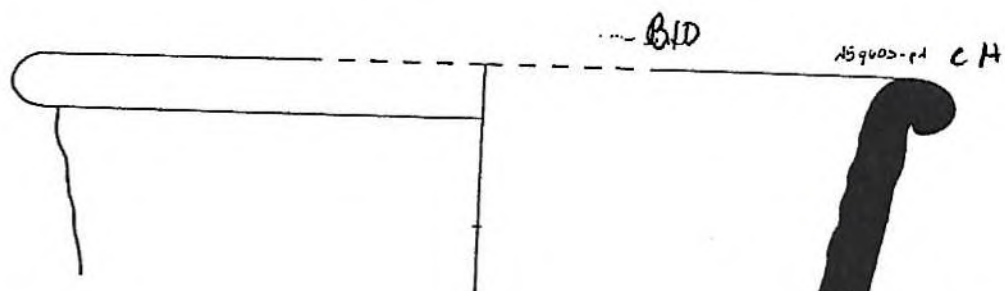

BID

A8900-p1 CH



AKSBID

STRAIGHT SIDED JARS

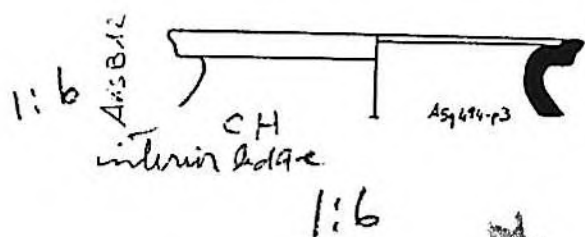

1:6

A85B12

CH
interior ledge

A8949-p3

1:6

*

JAR W/ INTERIOR
LEDGE

A85A8a
A8981-p2

f32



CH

Collared Rim
JAR

*



AK

CH

STRAIGHT SIDED
DEEP BOWLS

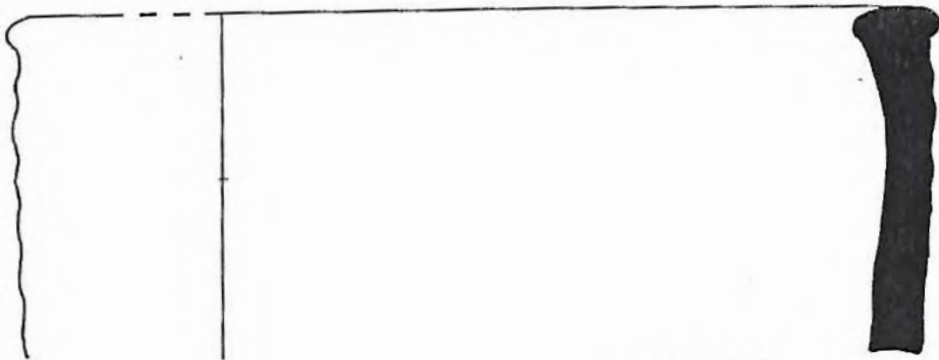

A19507-p1
CH
AKSB10

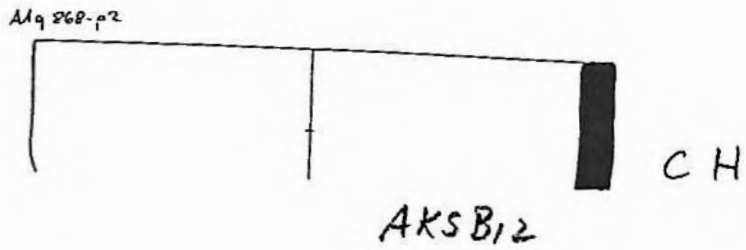

AKSB12

CH

A19860-p2

CH

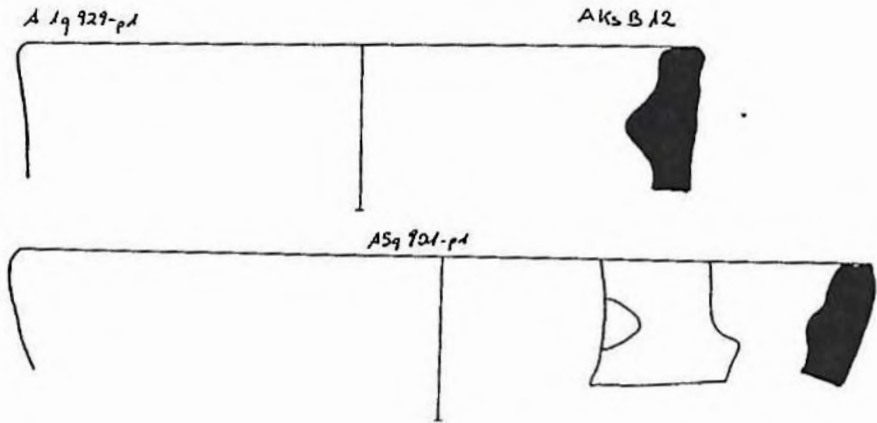

AKSB12

AKSB12
CH
with interior lug

WITH
INTERIOR
LUG

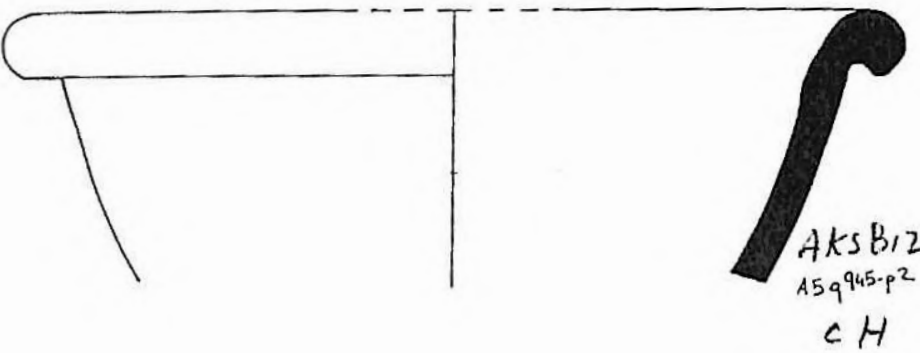

AKSB12
A59945-p2
CH

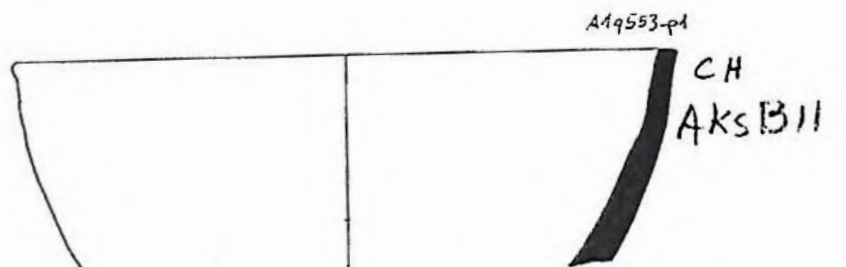

CH
AKSB11

A19553-p1

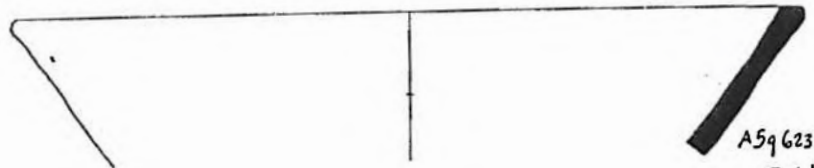

CH
AKSB11
Ca 116

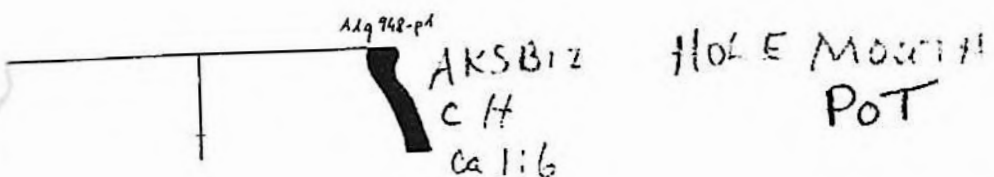

A19948-p1
AKSB12
CH
Ca 116

HOLE MOUTH
POT

5

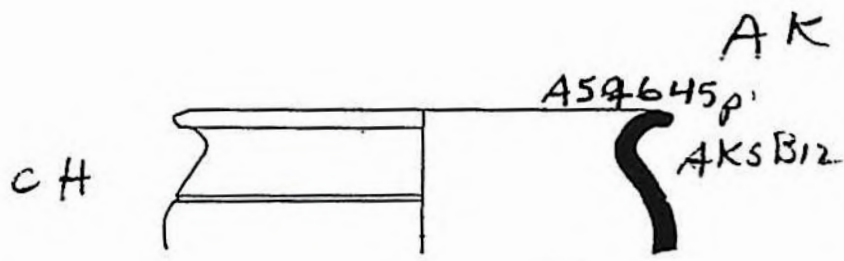

CH
 Deep Bowls
 with slightly carinated bodies

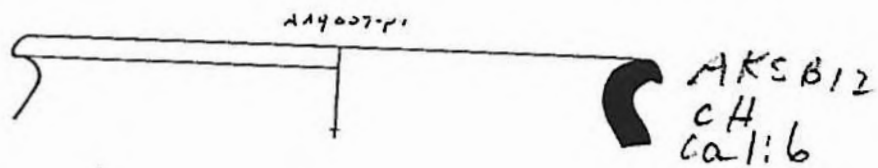
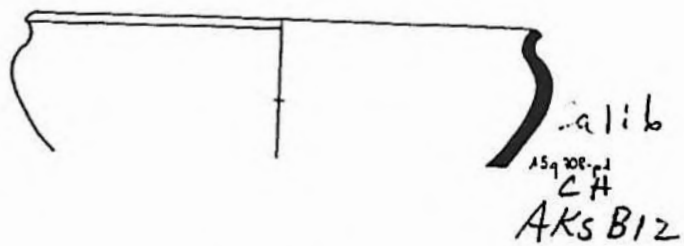
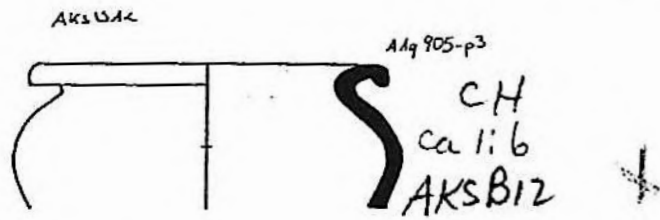
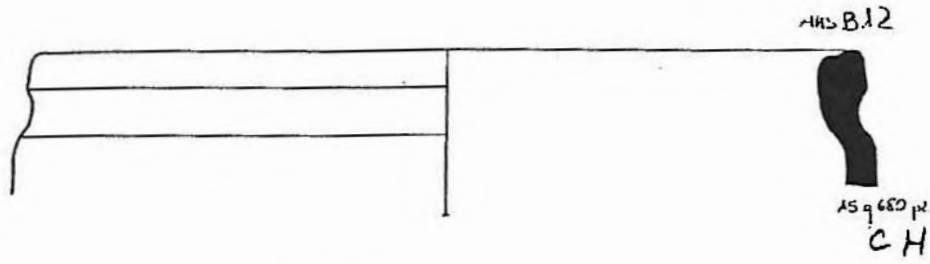
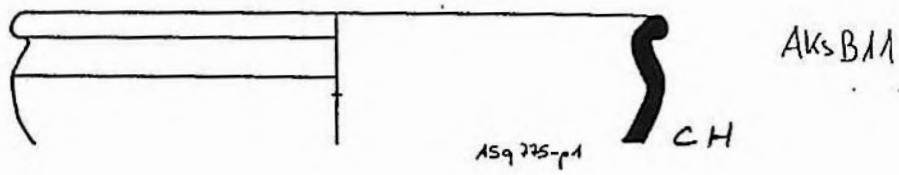

AK

CH

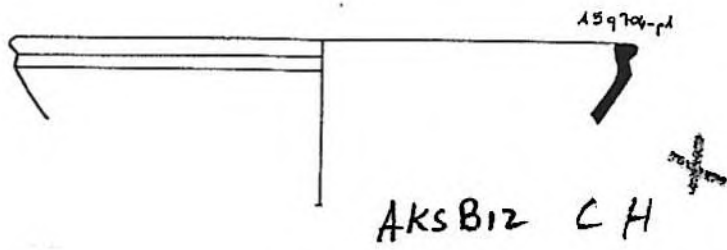

CARINATED BOWLS

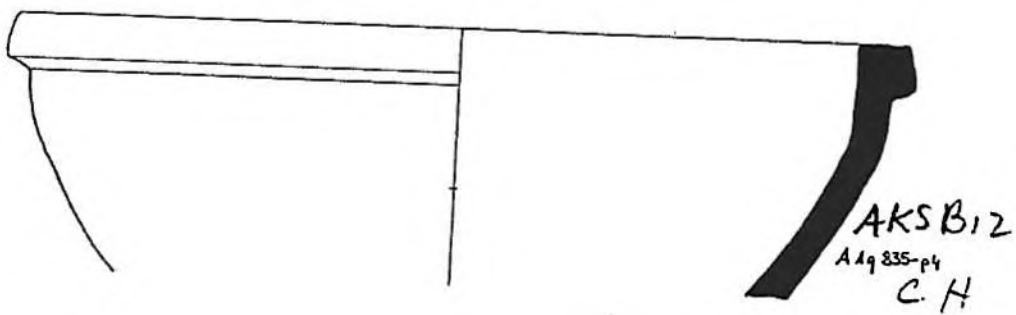
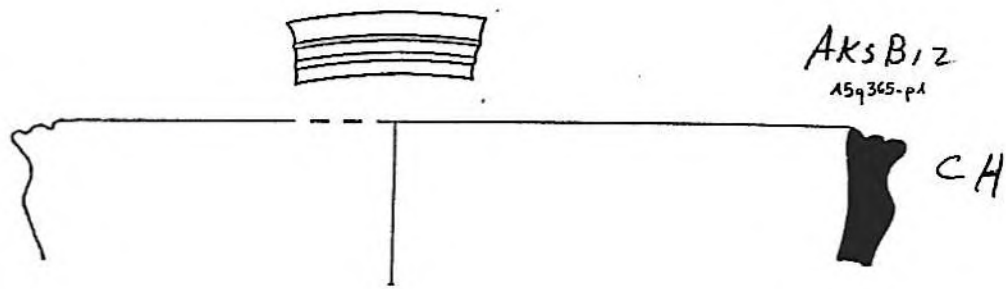

FLAT RIM BOWLS

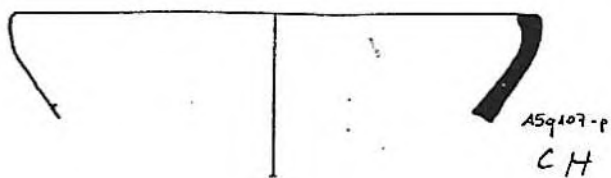
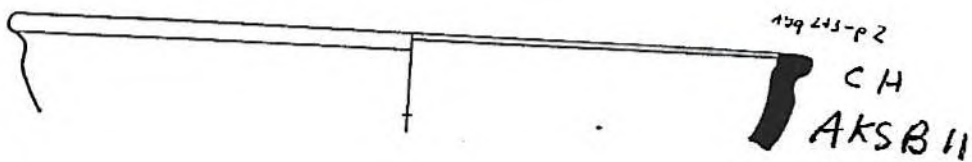

AKS BM



AK

CH
Other Bowls

+

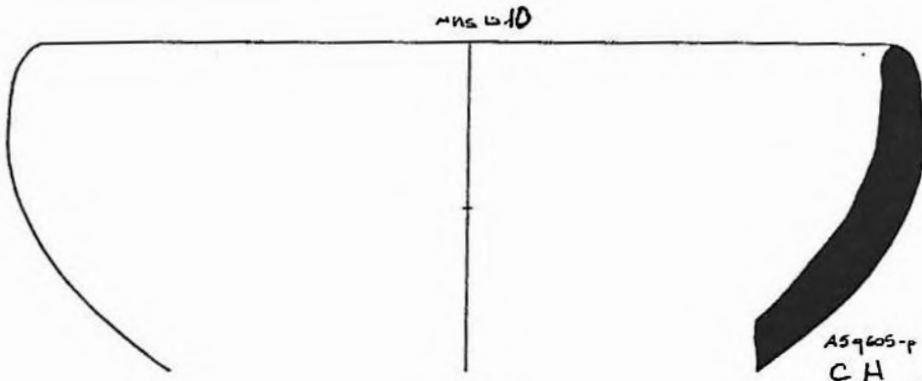

ROUNDED
PROFILE
BOWL

AS9605-p
CH
AKSB10

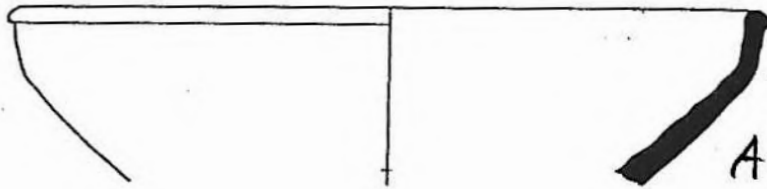

AS9437-p1
CH
AKSB11

OTHER
Bowls

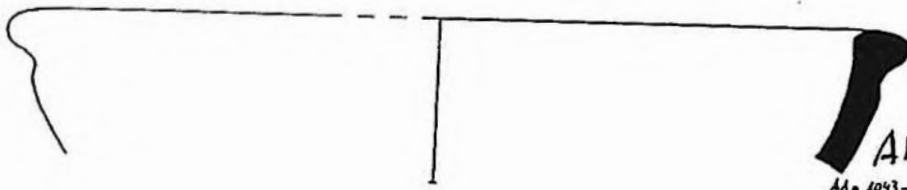

AKSB12
AA92043-p1
CH

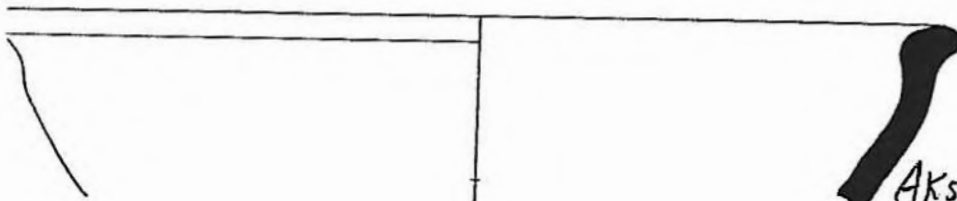

AKSB12
AA9862-p2
CH

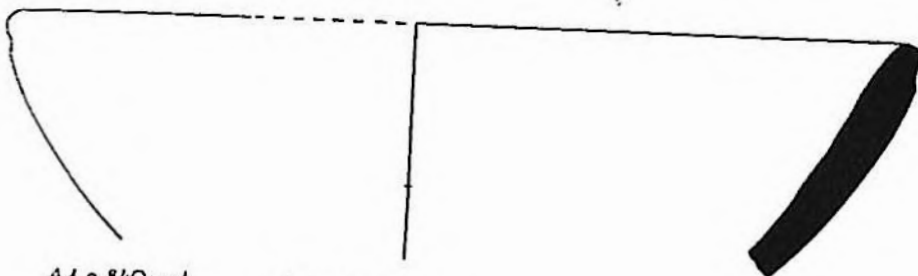

AA9840-p1
CH
AKSB12

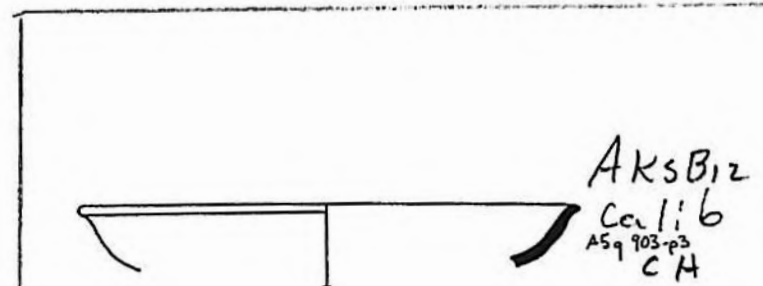

AKSB12
Callib
AS9903-p3
CH

Platter



Callib
AA9840-p3
CH
AKSB12



AK

A8s A8(a)
CH
Misc

A8s A8
A8q 12-p7
f12

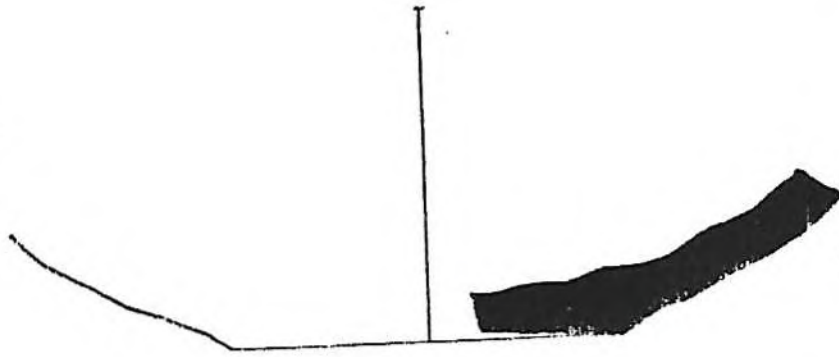

CH

[Faint handwritten notes]



A8s AB
A8q 117-p4

CH

f12

CH

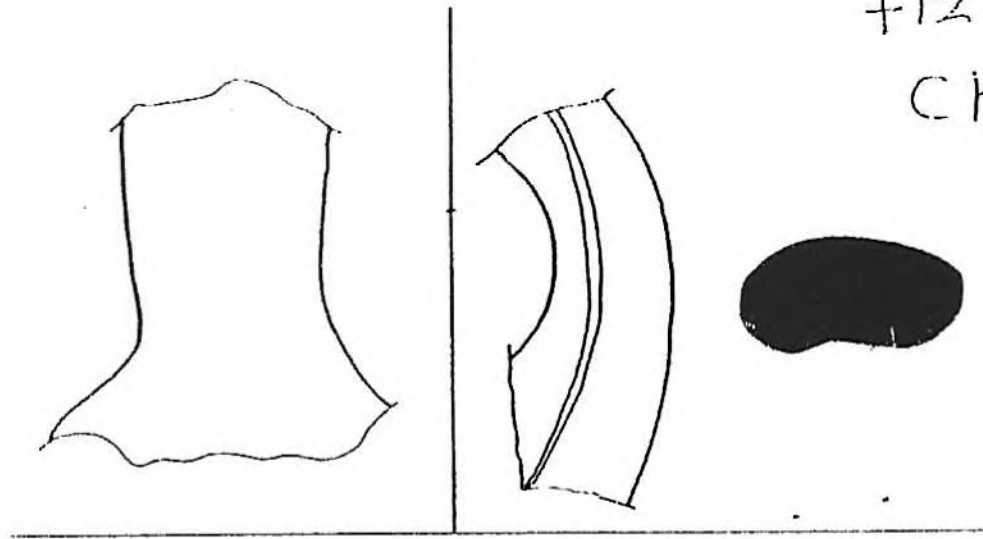

A8s A8a

A8q 87 r'
CH
f32

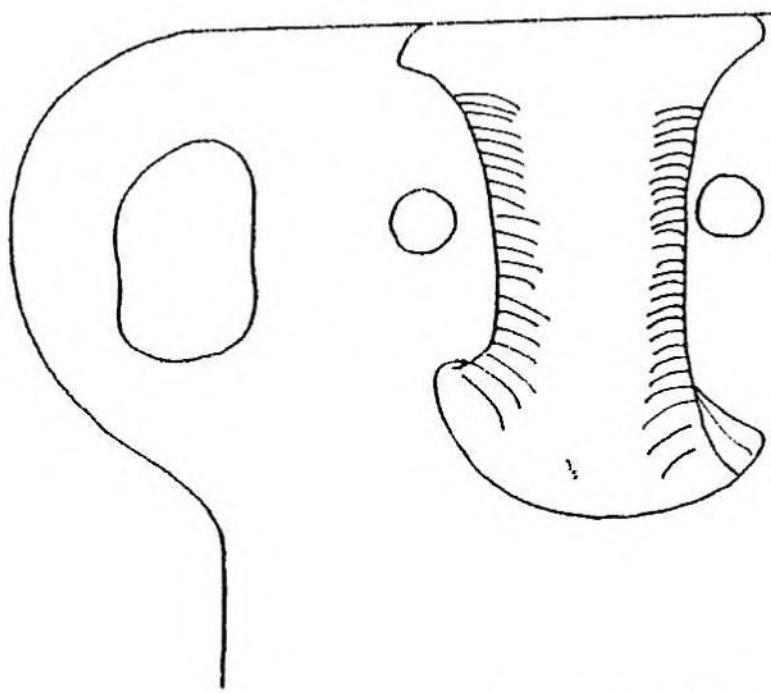

AK

FC
NECKED JARS
+ BOTTLES

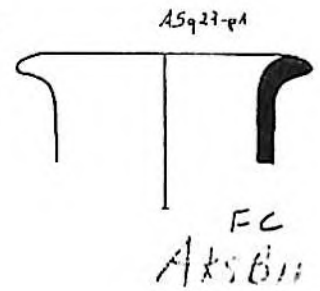
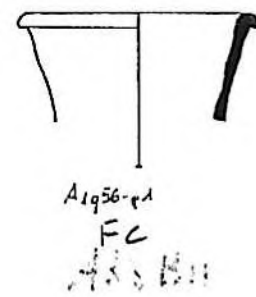
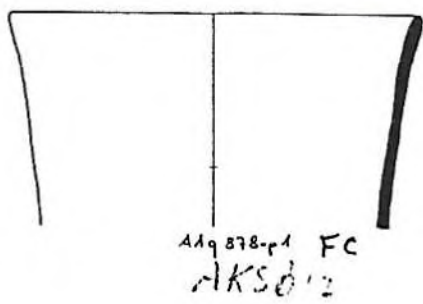
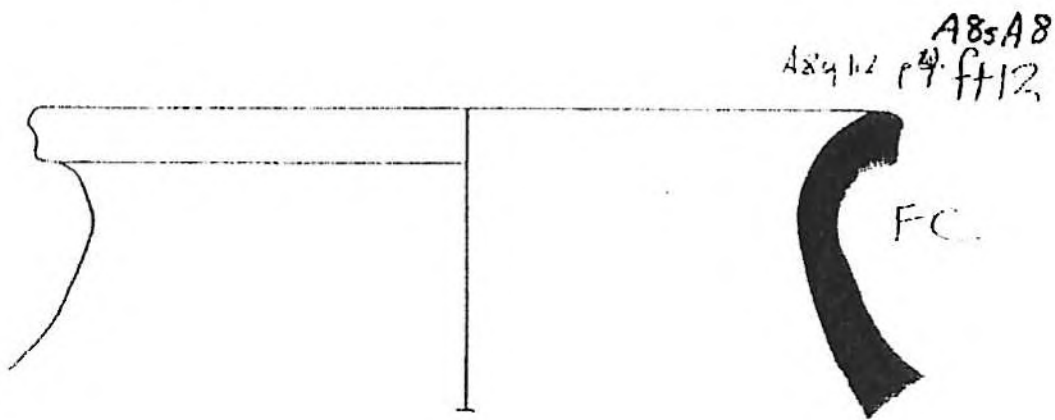
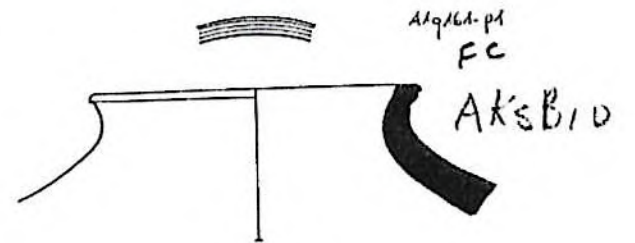
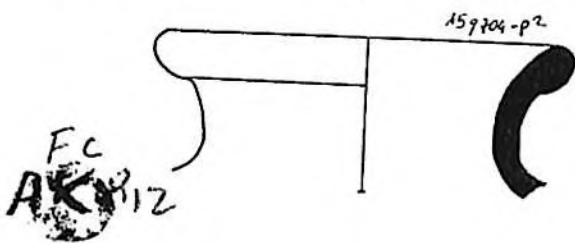
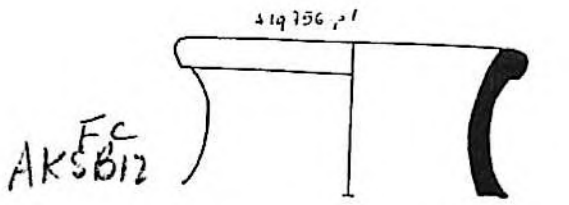
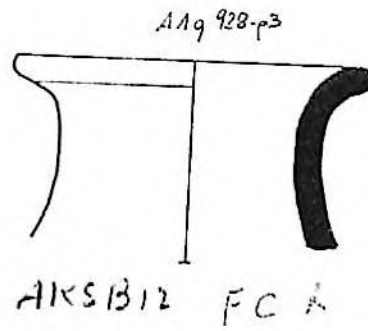
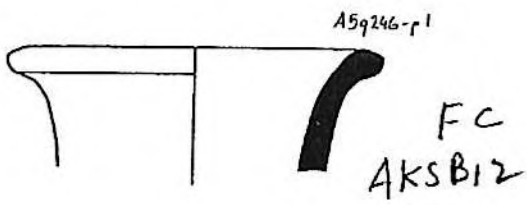
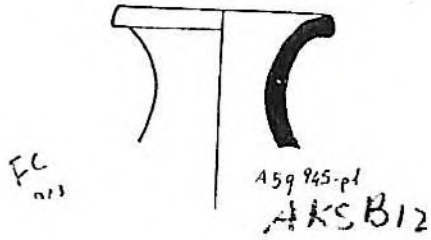

AK

FC
STRAIGHT +
HOLE MOUTH
JARS

A85 A8

A20109-p6

f+12

FC

X

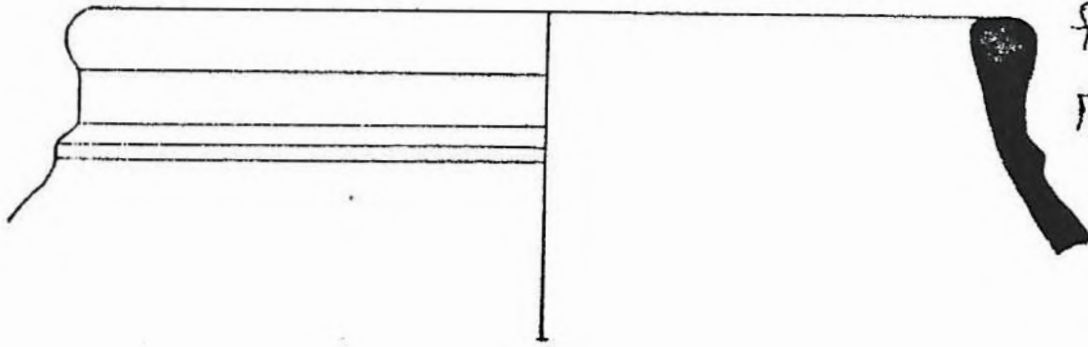

A85 A8

A20112-p5

f+12

FC

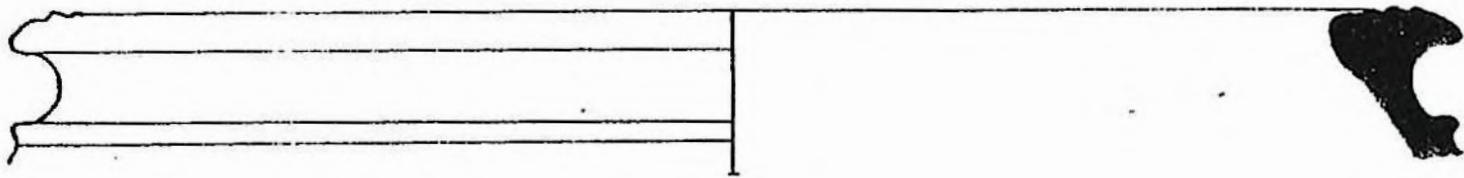
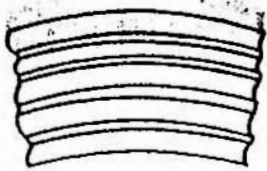

AK

$w_1 = 0.5$

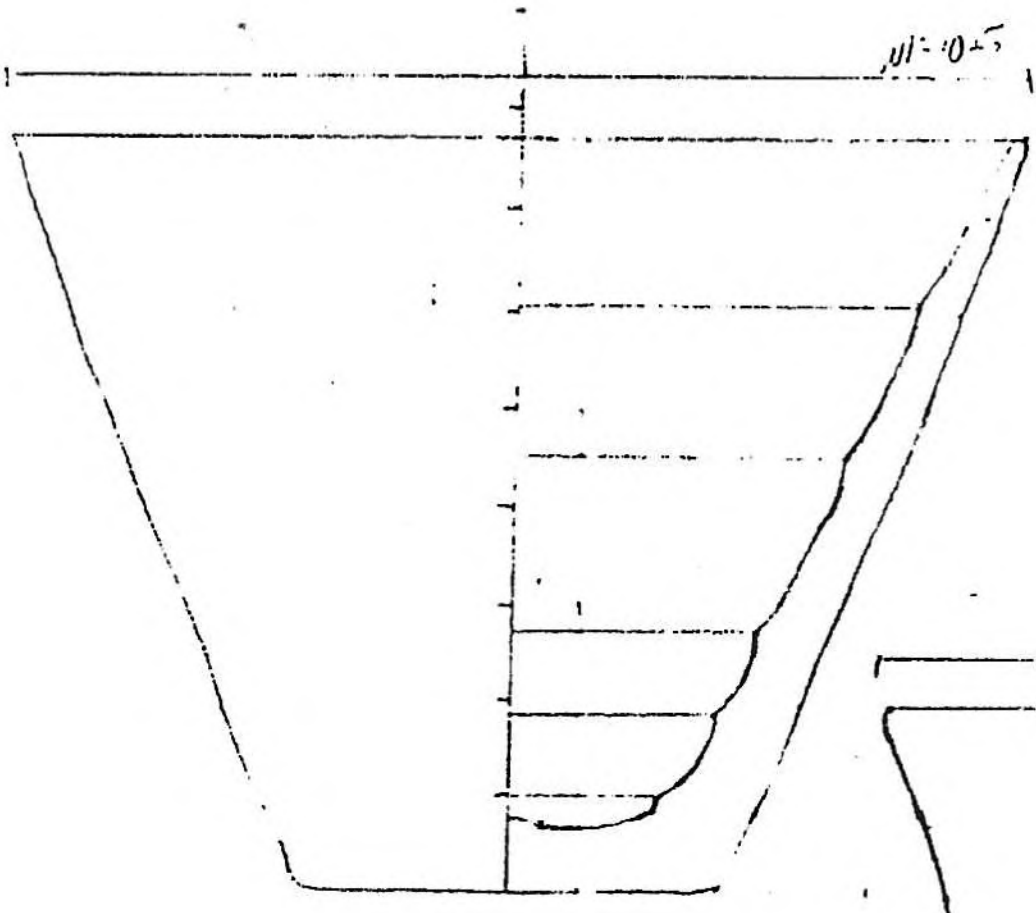

1:1 $w_3 = 4.3$

A1.78

FC

CONICAL CUPS

$w_1 = 11$

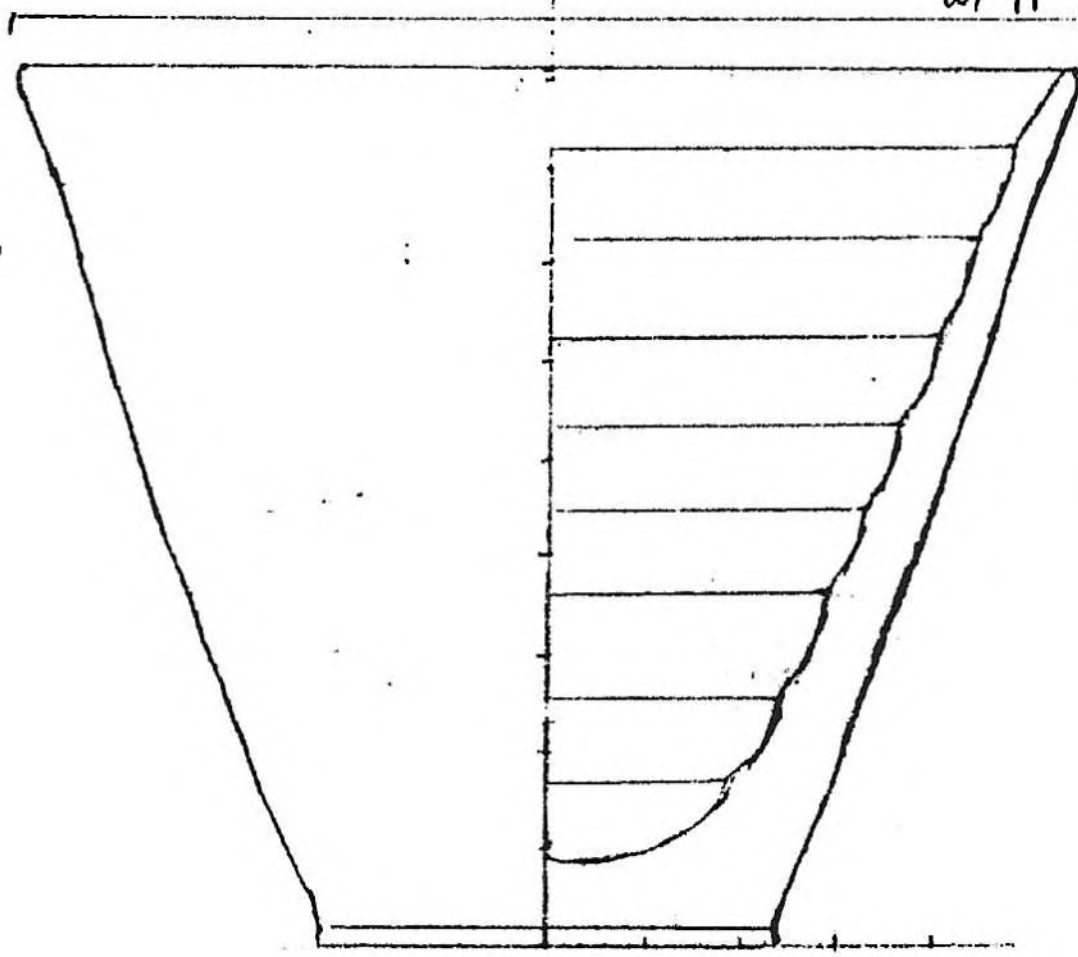

$w_3 = 4.5$

1:1 A1.232

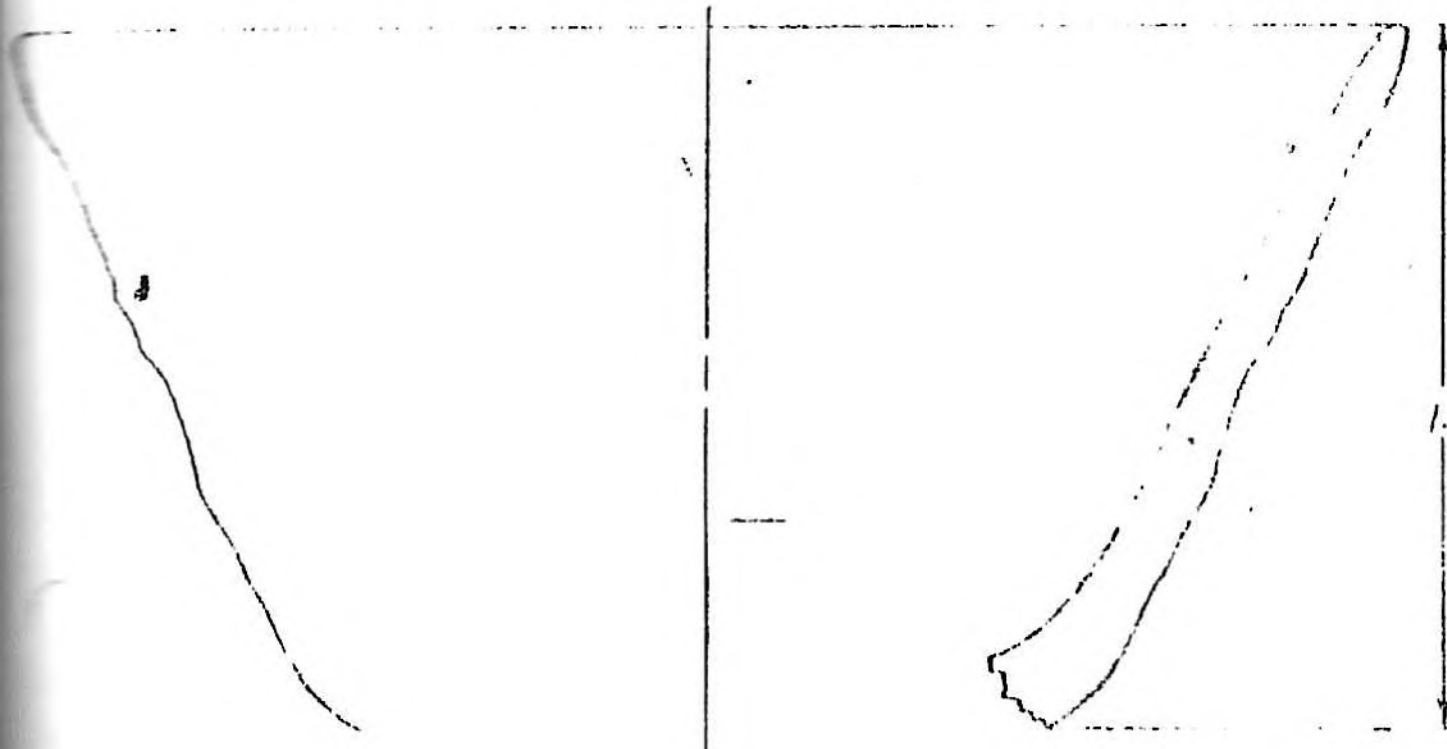

FC

1:1

A1.965

12

AK

FC
CONICAL CUPS

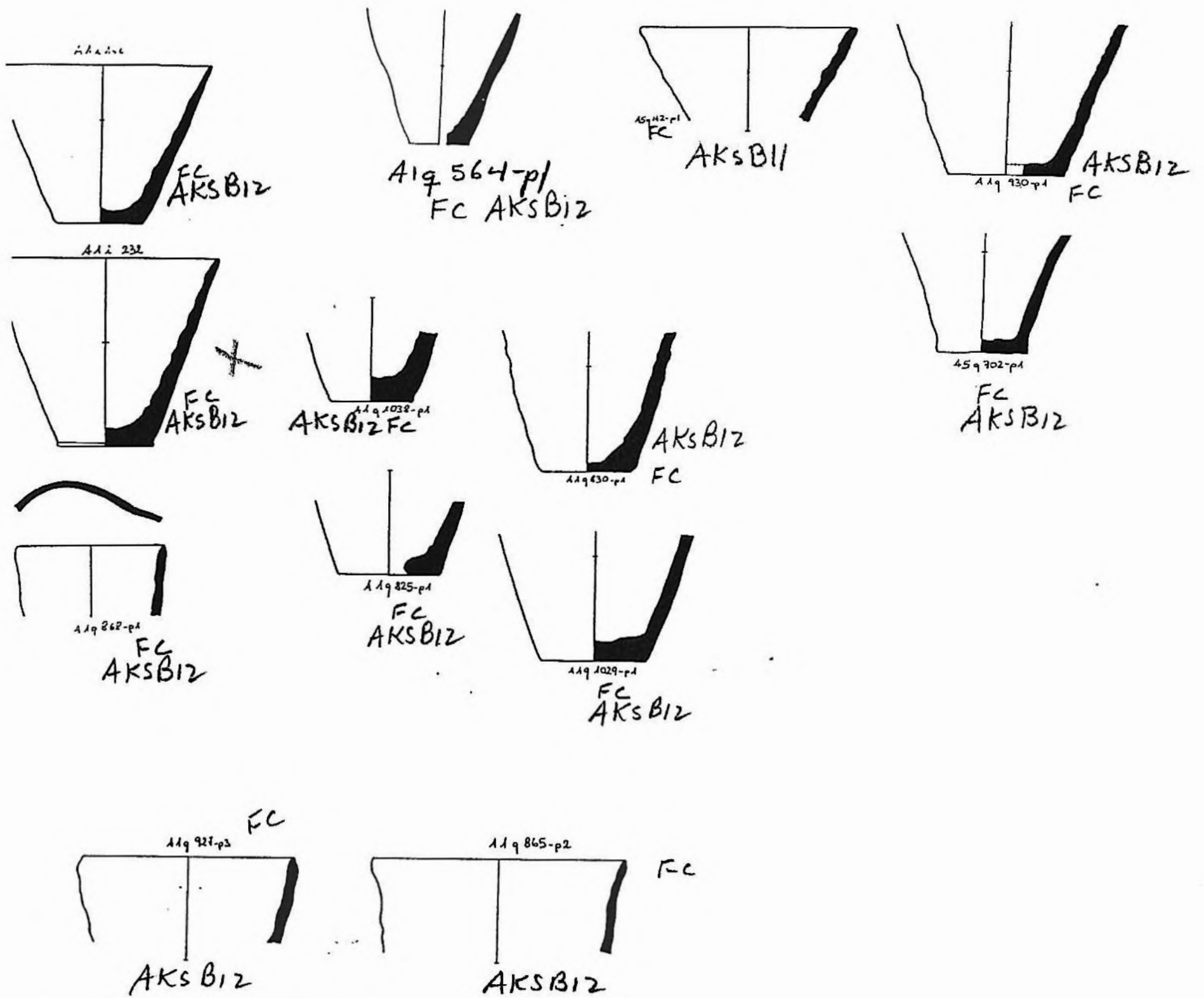

STRAINERS

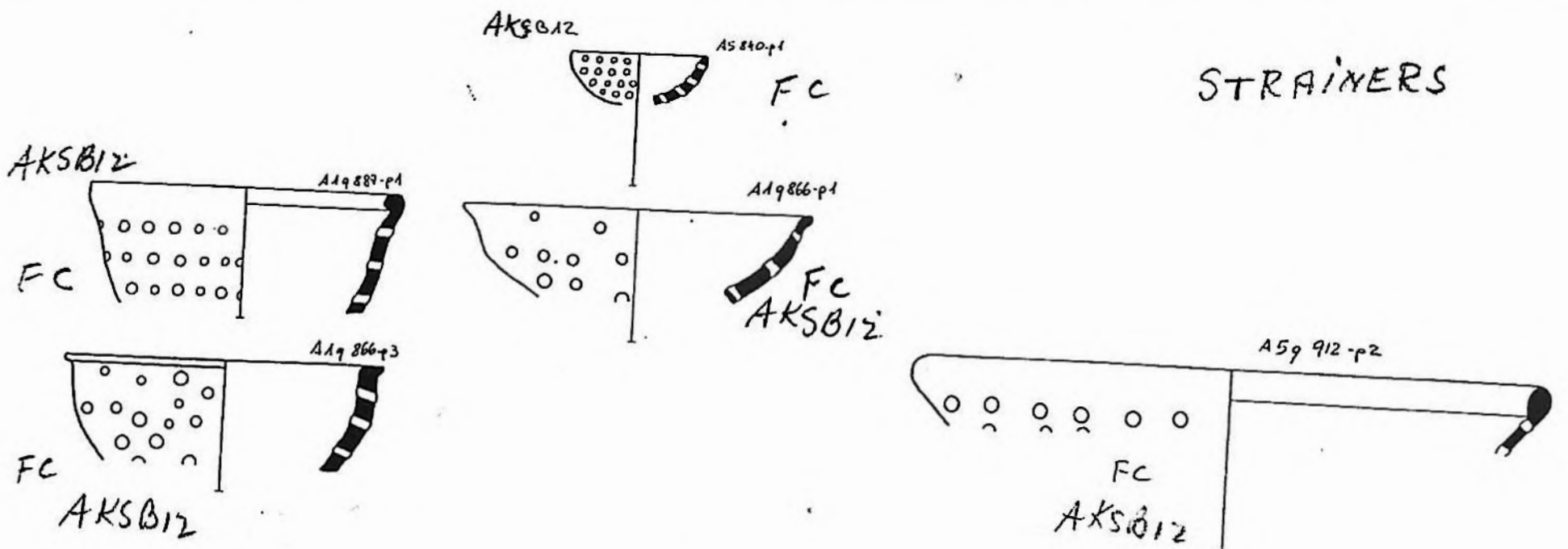

AK

FC

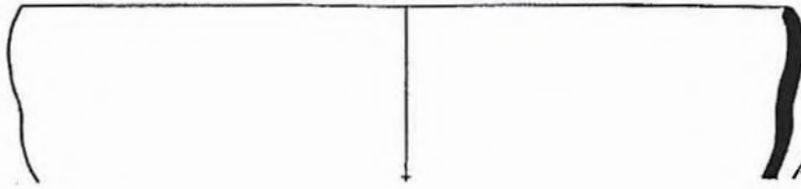

FC
 A4931-p1
 AKS B12

STRAIGHT
 SIDED
 DEEP BOWLS

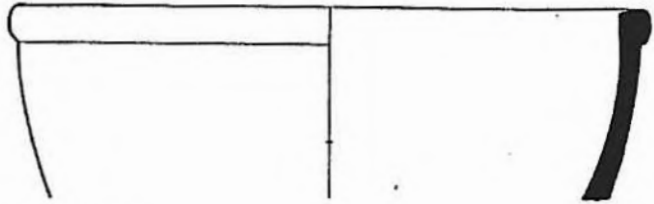

A494029-p
 FC AKS B12

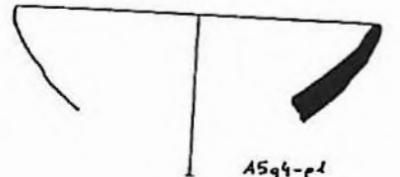

A594-p1
 FC
 AKS B11

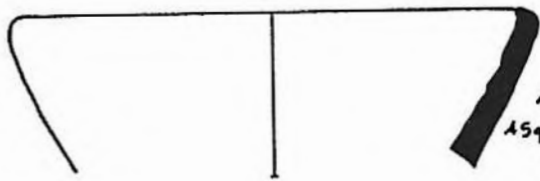

AKS B11
 A594029-p1
 FC

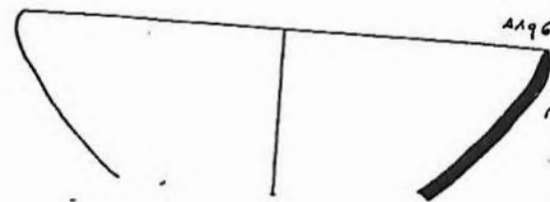

A4962-p1
 FC
 AKS B11

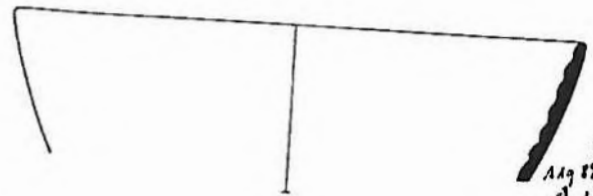

FC
 A49876-p1
 AKS B12

FC A83A8 A59114-P4 ft 12.

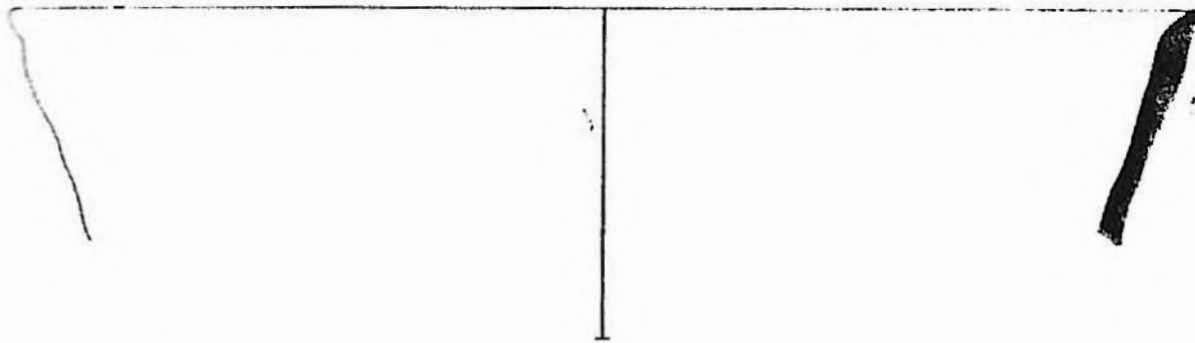

AK

FC
Deep Bowls
GENERALLY LATE

A8sA8

A8q115-p3
ft12

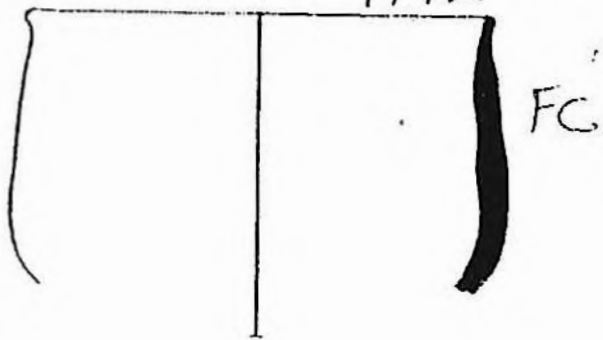

31

A8sA8

A8q118-p2
ft12

FC

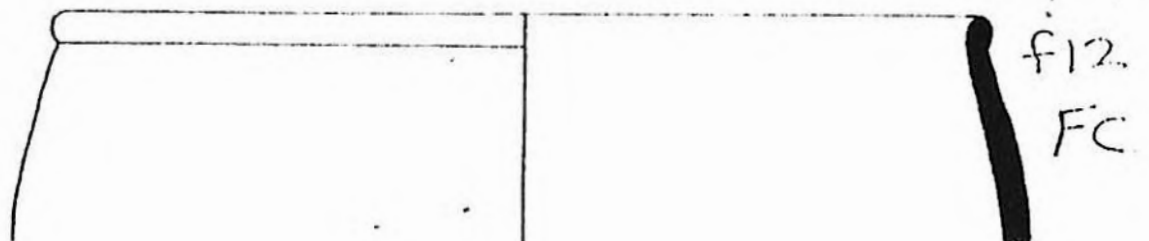
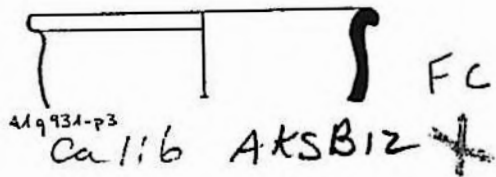
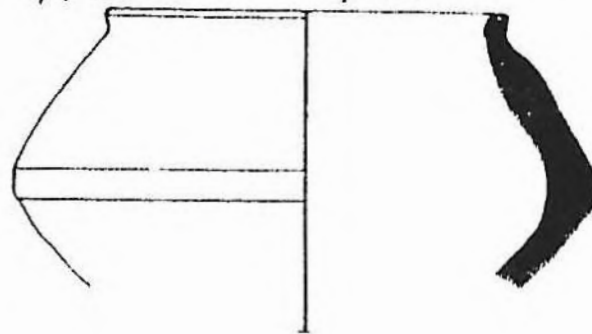

A8sA8

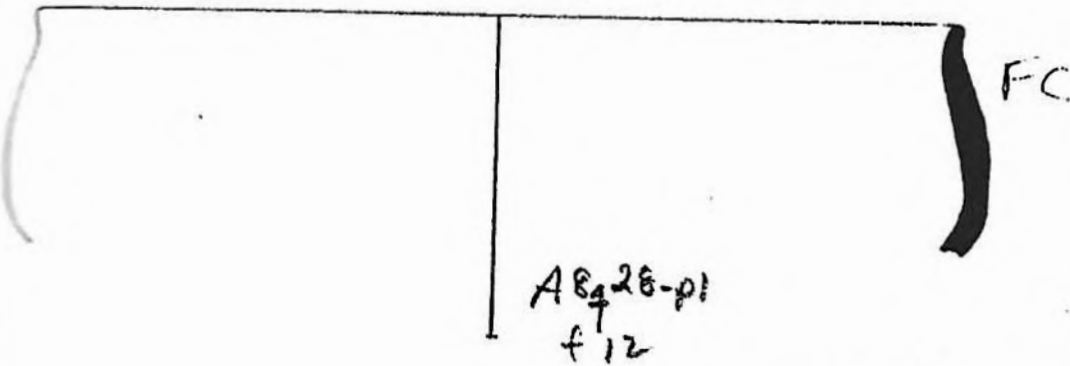

A8q28-p1
ft12

30

A8sA8
A8q116-p2
ft12

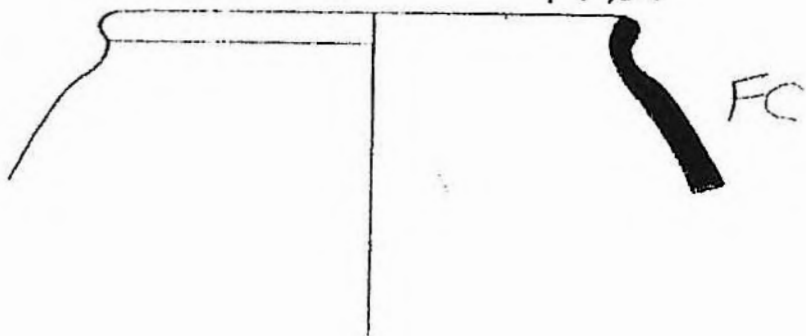

A8sA8
A8q111-p3
ft12

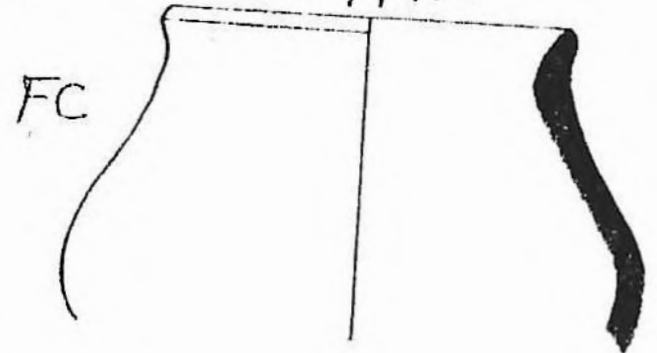

A8sA8
A8q111-p4
ft12

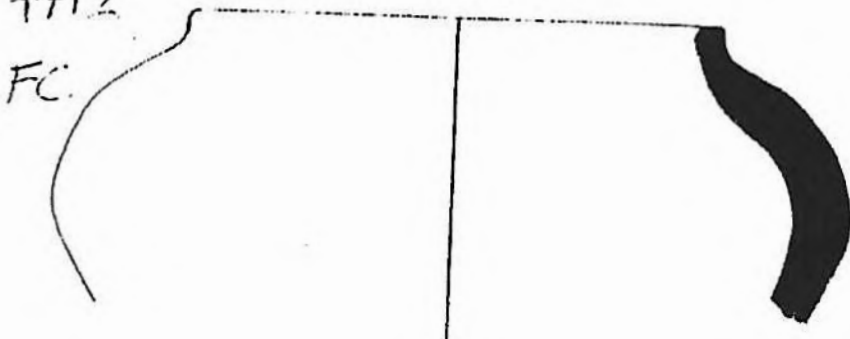

A8sA8
A8q109-p4
ft12

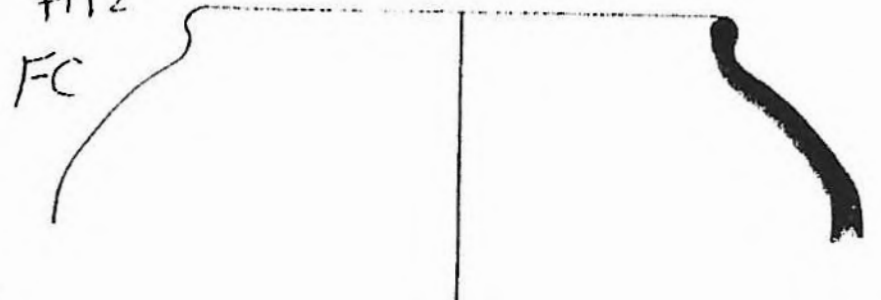

15

AK

FC

ROUNDED
PROFILE BOWL

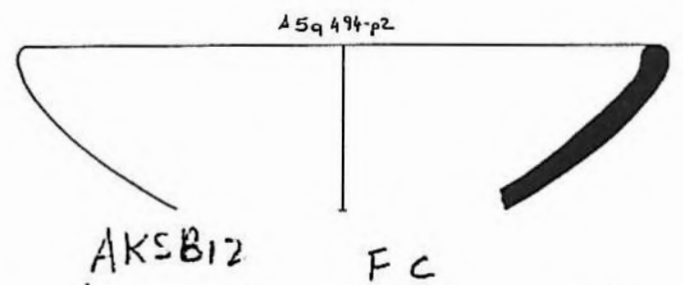
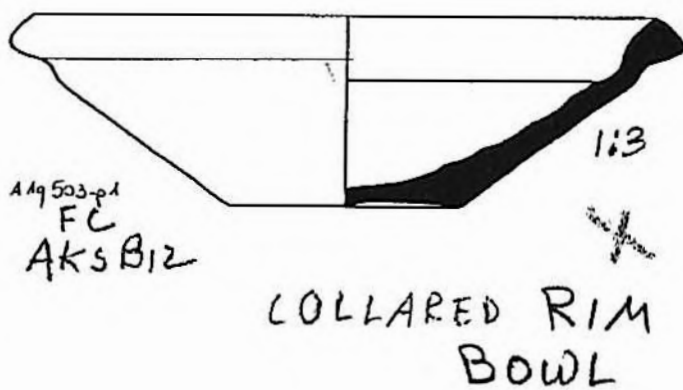
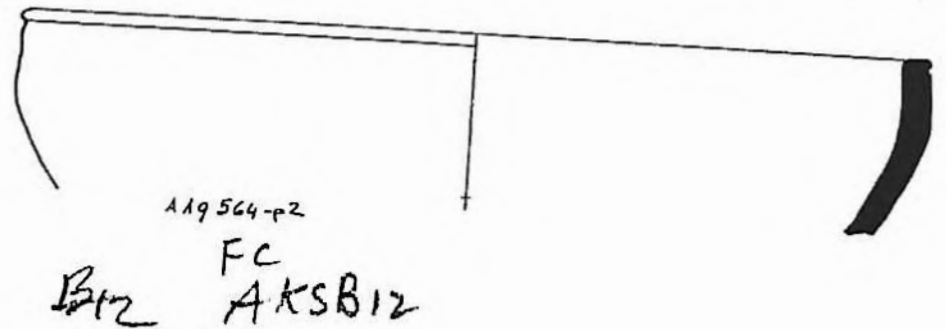
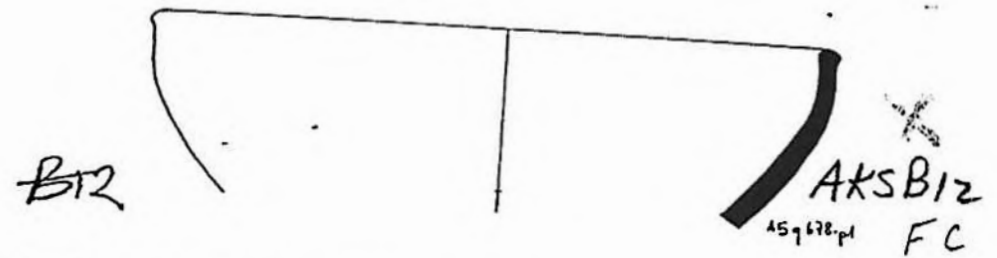
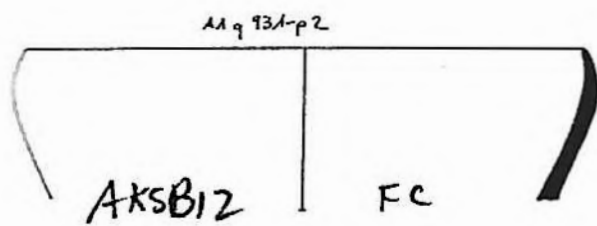
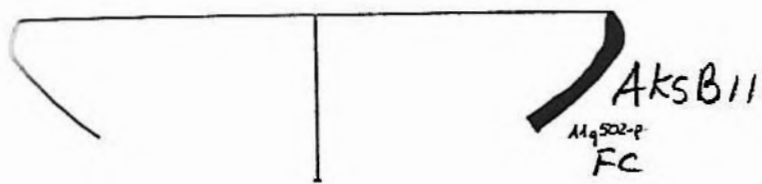
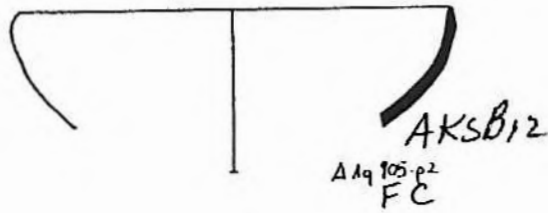
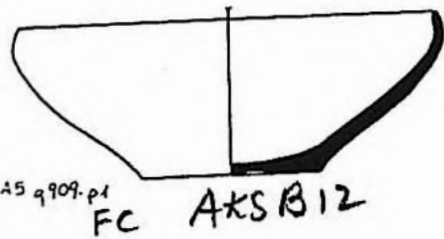
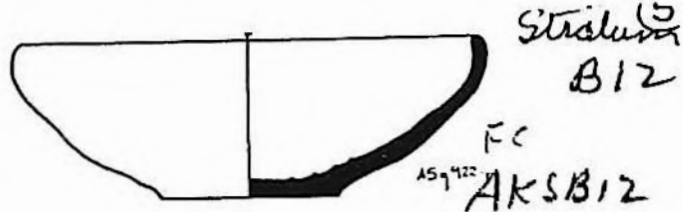

Slightly curved rim

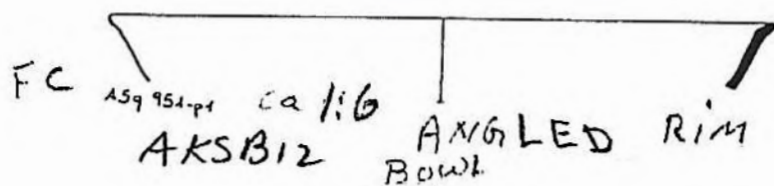

AK

FC
CARINATED Bowl.

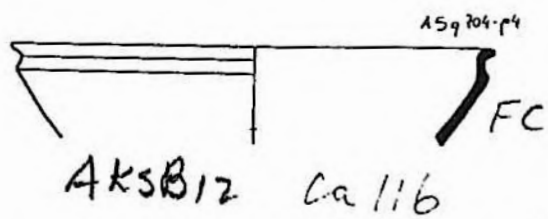
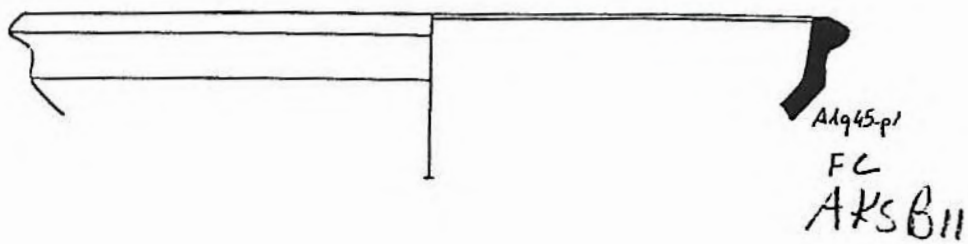
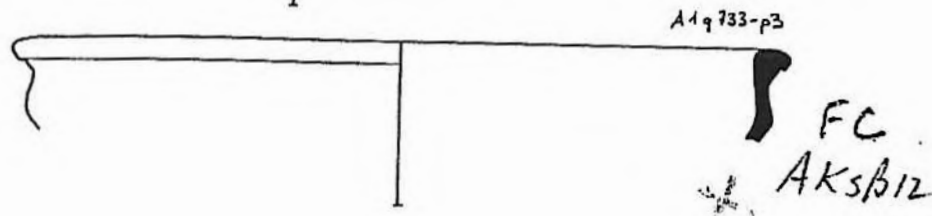
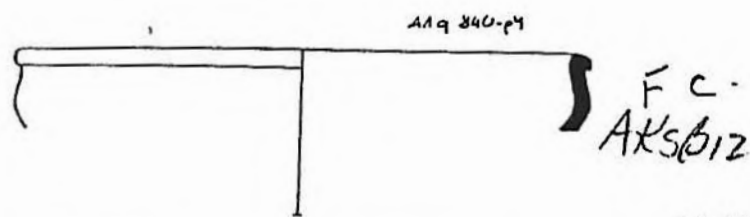
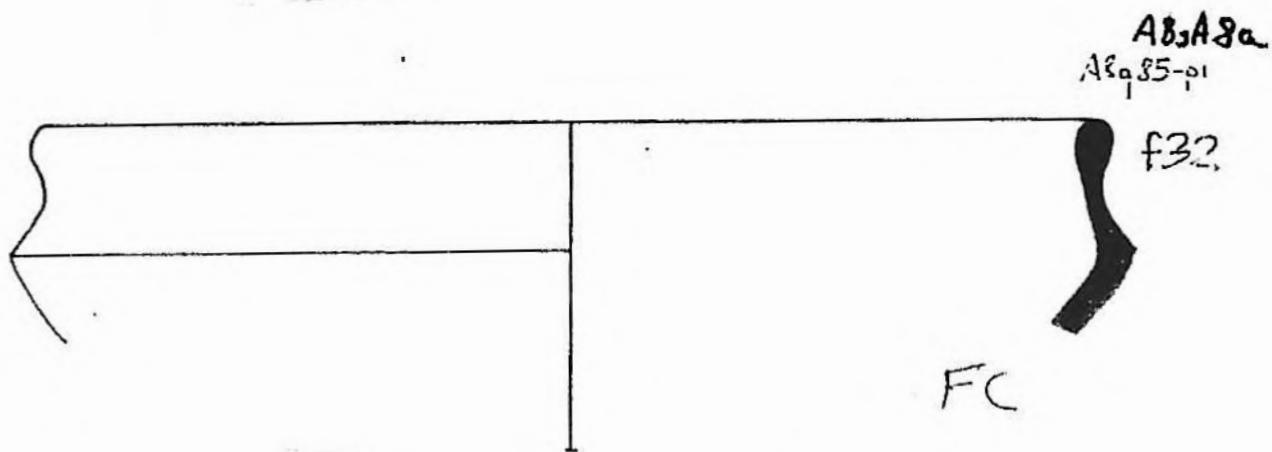
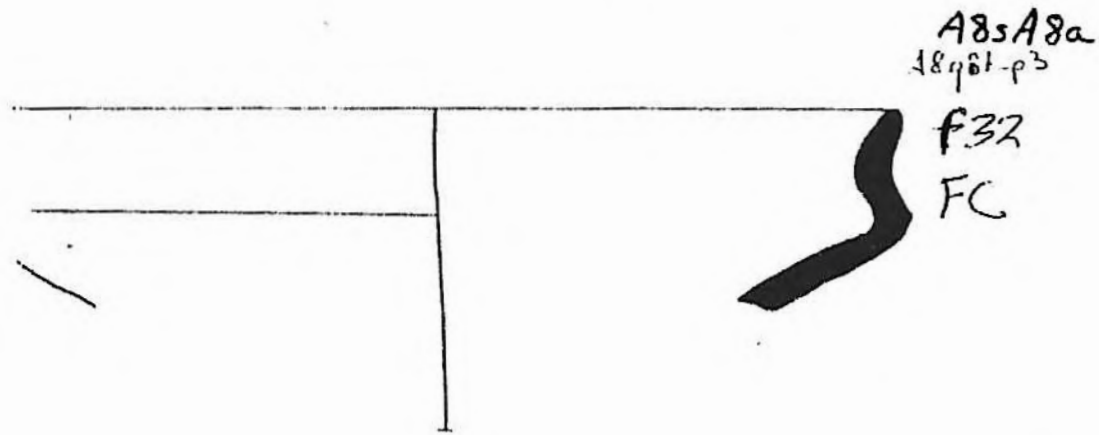

AK

FC
Bowls WITH INTERIOR THICKENED RIM

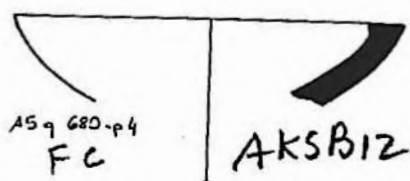
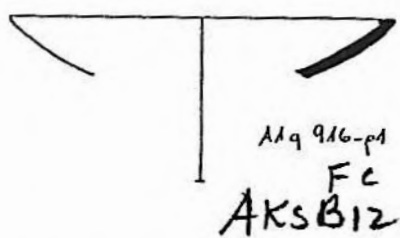
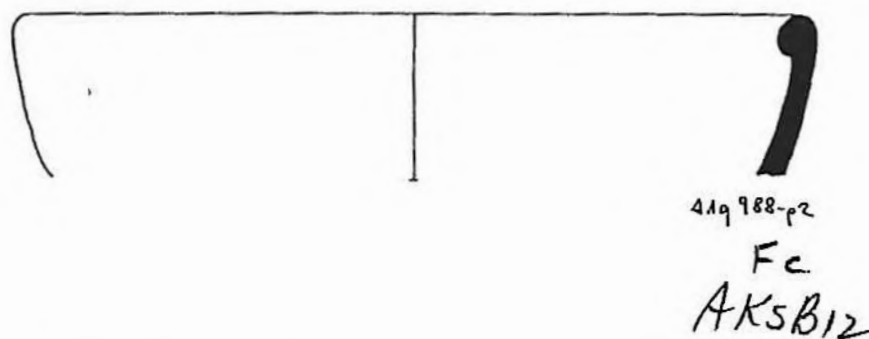
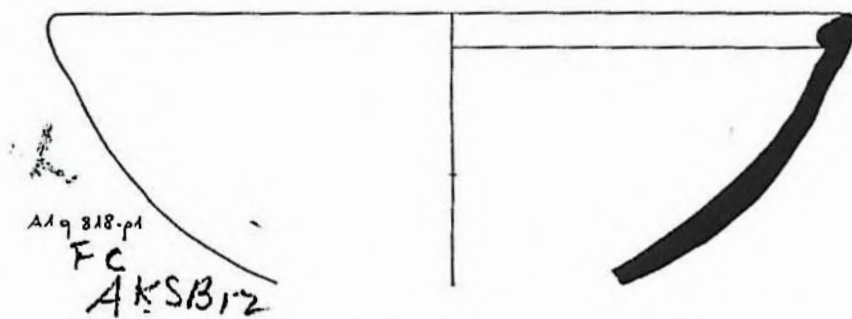
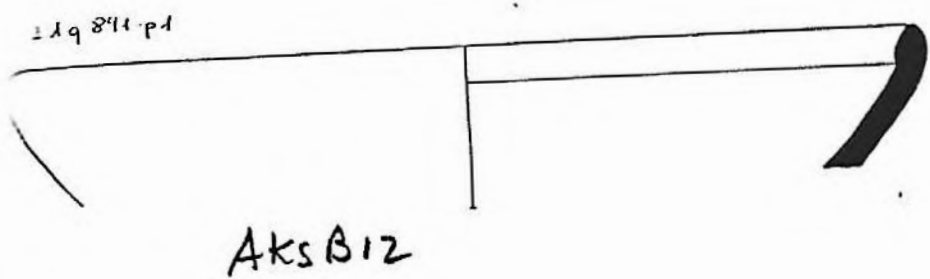
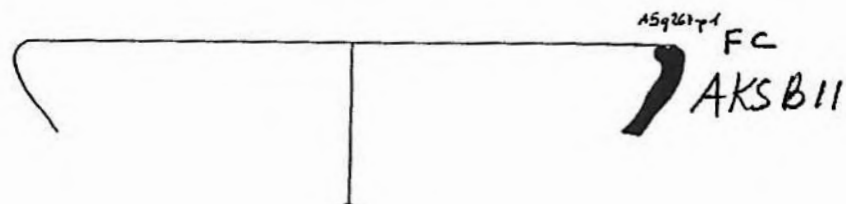
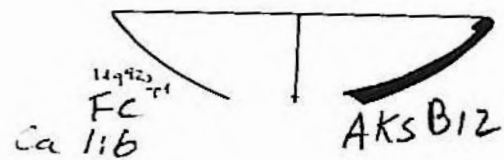
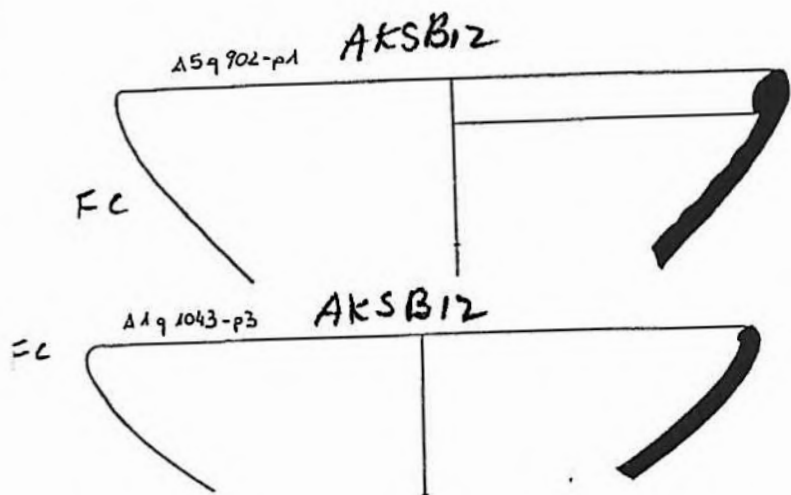

FLAT RIM PLATES

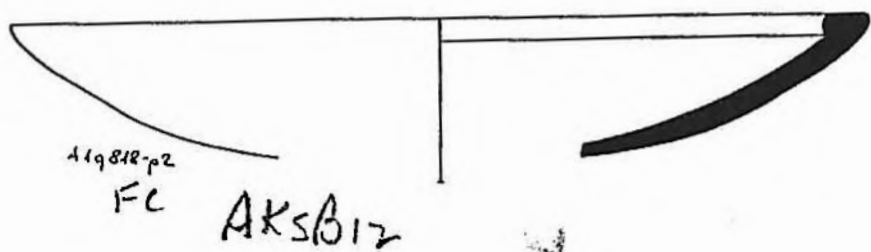

AK

S
SMALL JARS
with S-curved
profile

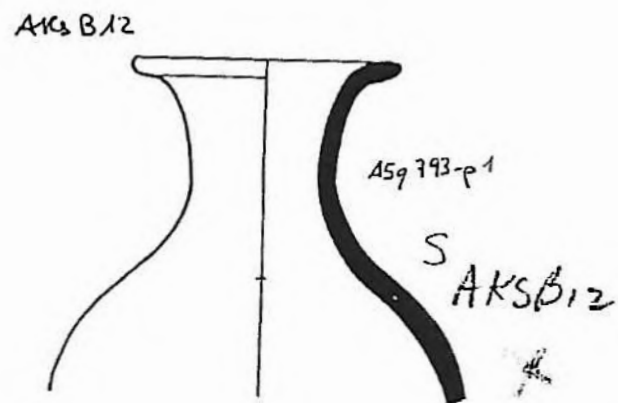
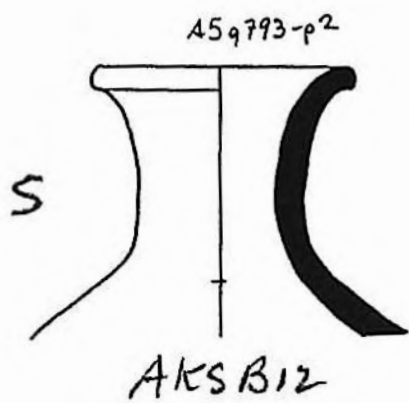
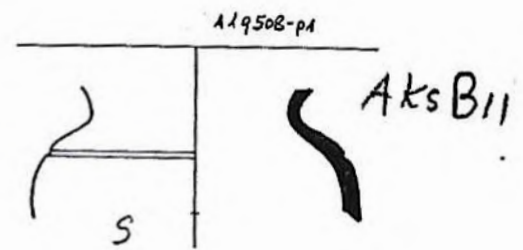
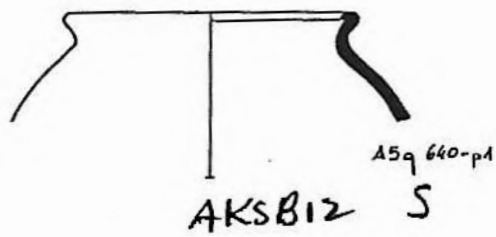
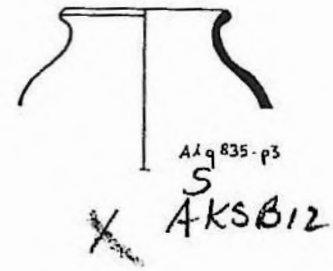
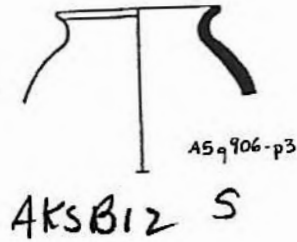
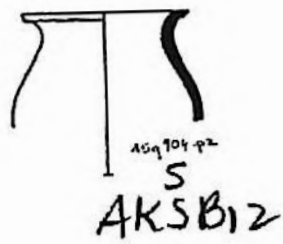
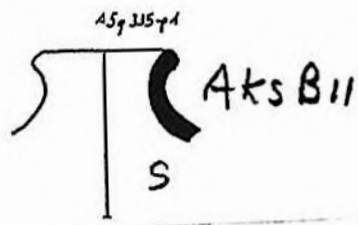

High
Necked
JARS

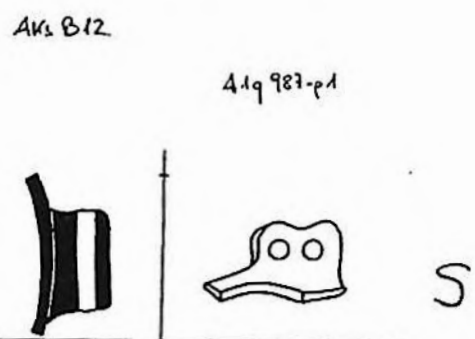
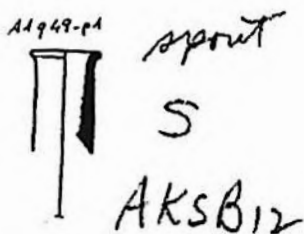

DOUBLE
LUG HANDLE

AK

S
CONICAL CUPS

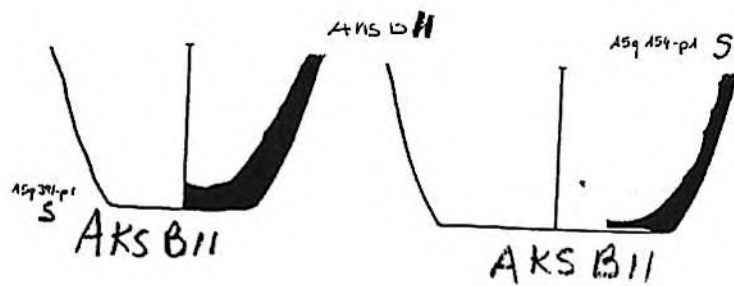
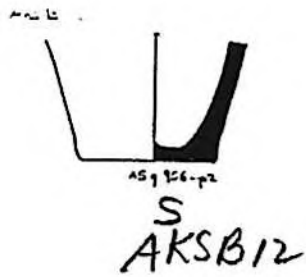
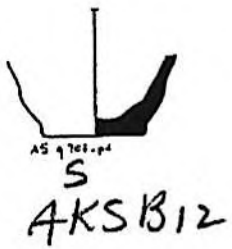
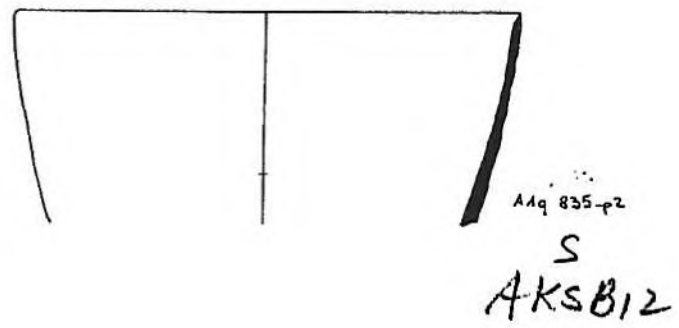
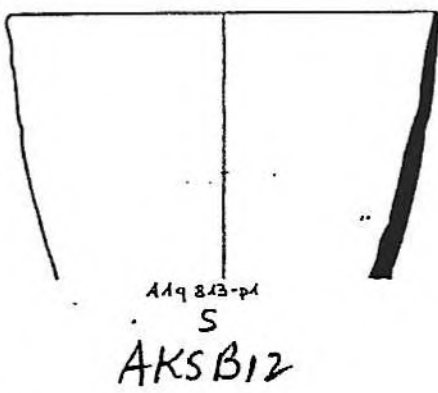
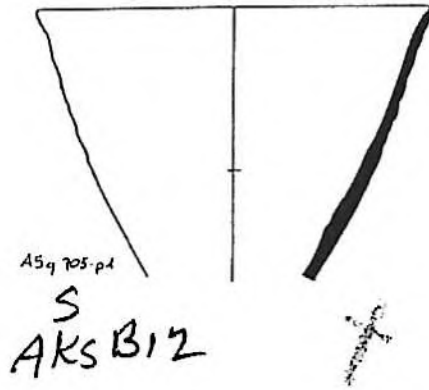

AK

S
Deep Bowls
+
CONCAVE BASES

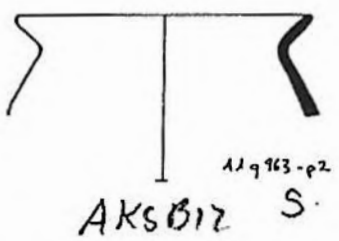

POTS

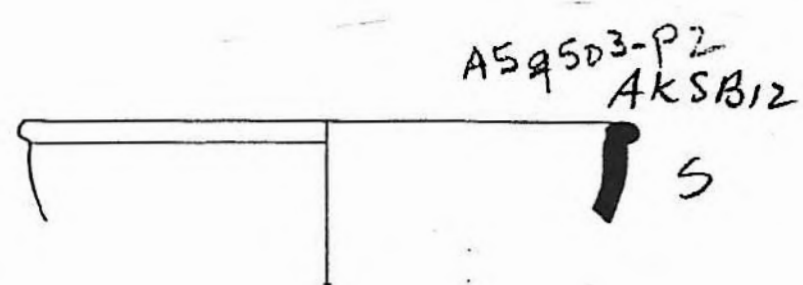
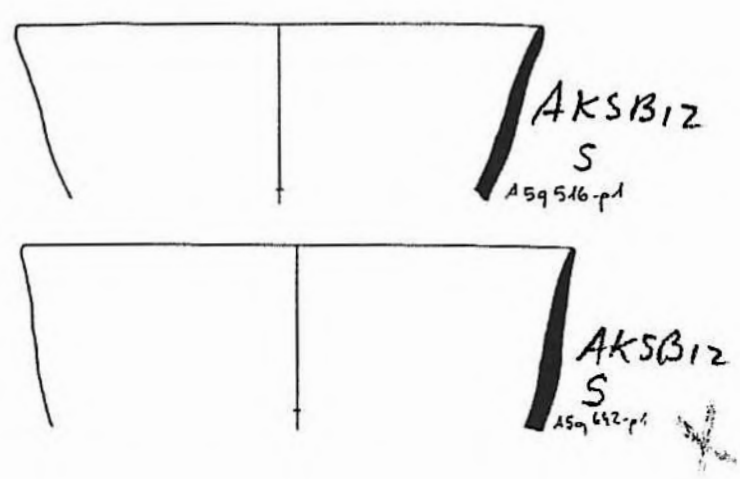
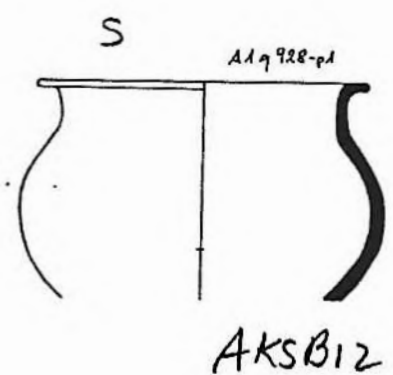
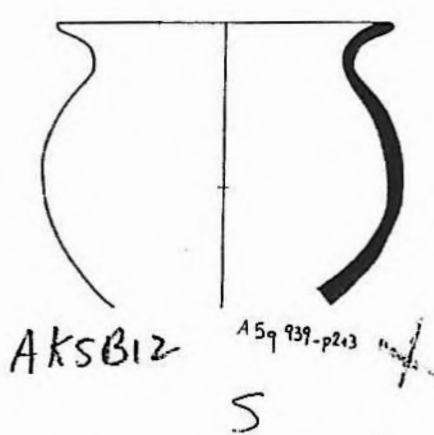

DEEP BOWLS

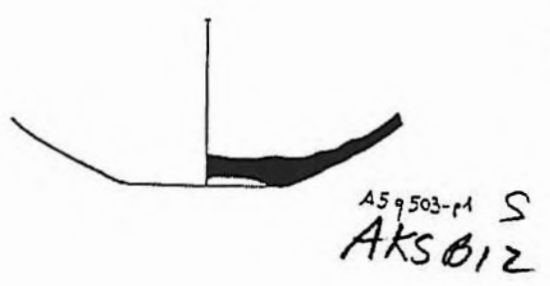
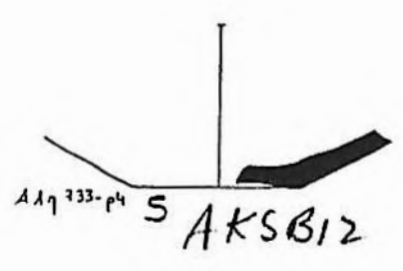

CONCAVE BASES

HK

BOWLS
CARINATED BOWLS
STRAINERS

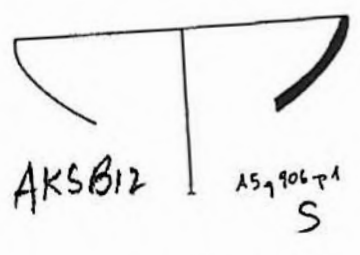
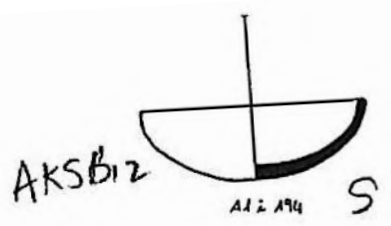

AKB11

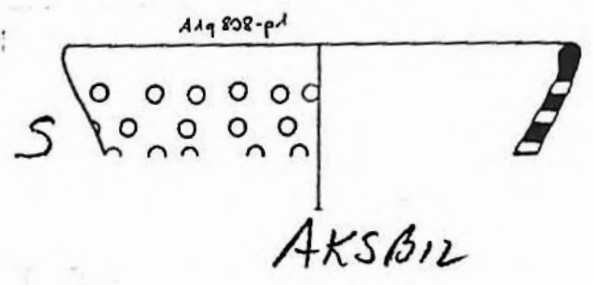
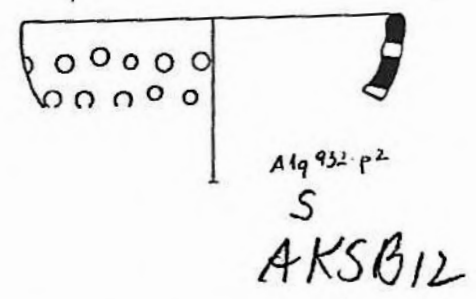
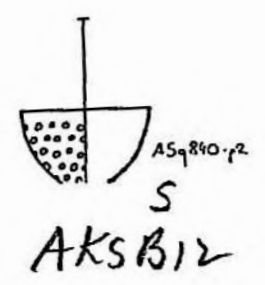
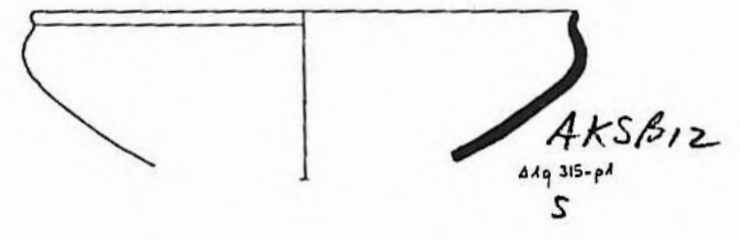
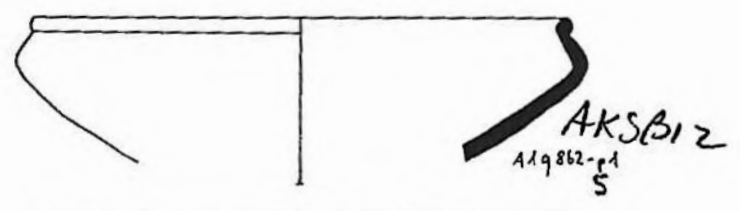
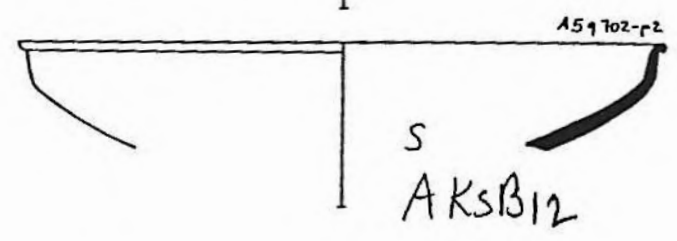
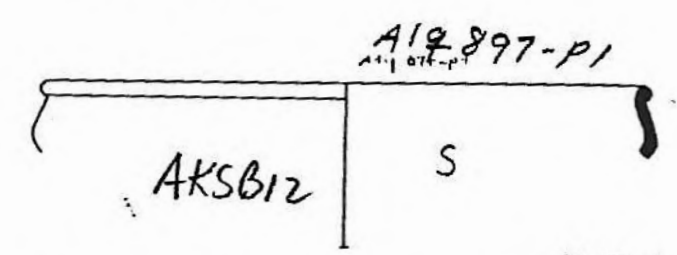
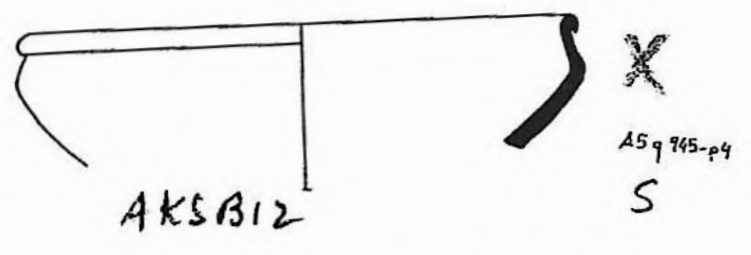
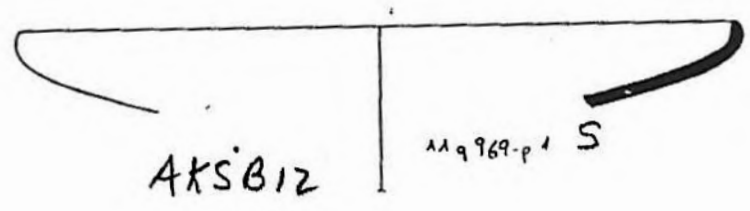
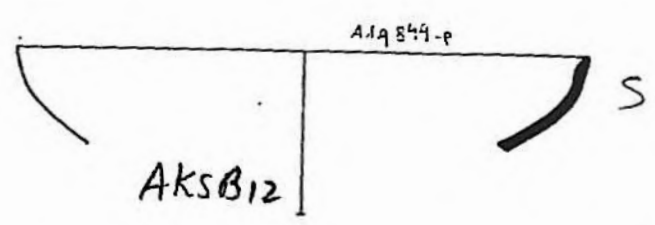
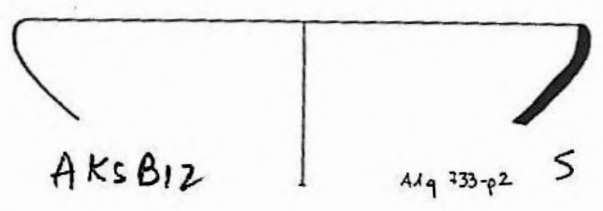
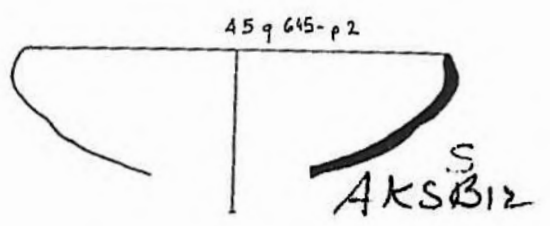
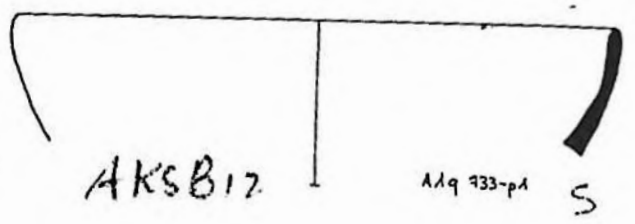
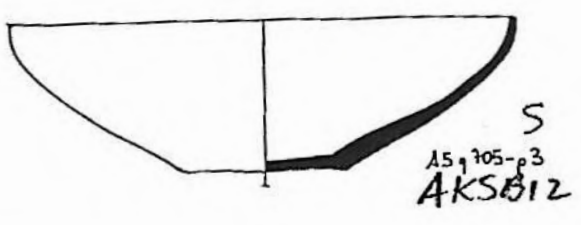
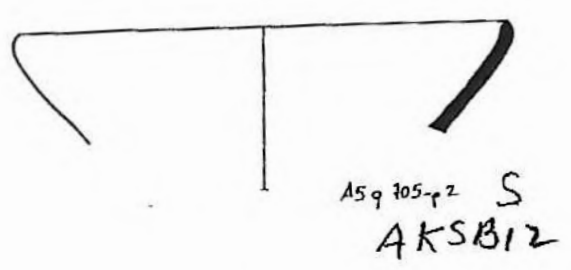
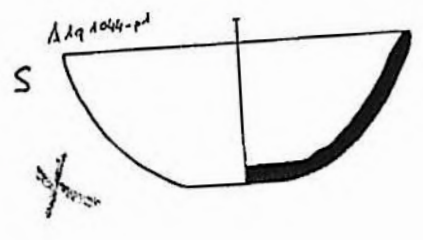

22

WS Ware

Jars

WS

AKSB12

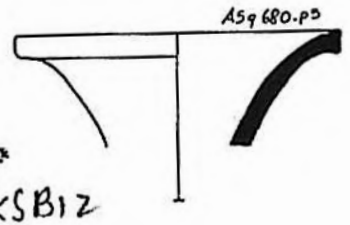

Narrow Necked JAR

Necked Jars

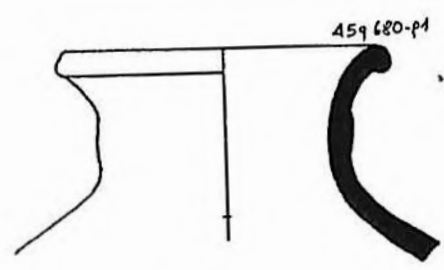

WS
AKSB12

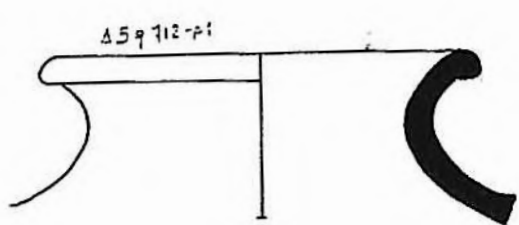

WS
AKSB12

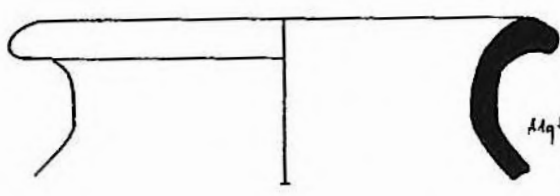

~~WS~~
AKSB12

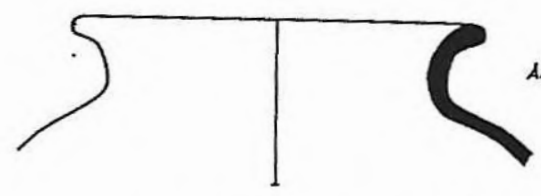

AKSB12 WS

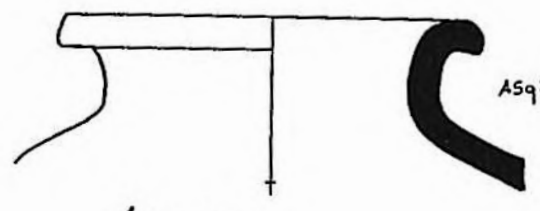

WS
AKSB12

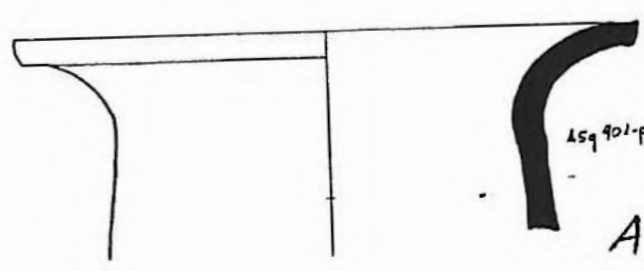

~~WS~~
AKSB12

Flaring Rim Jar

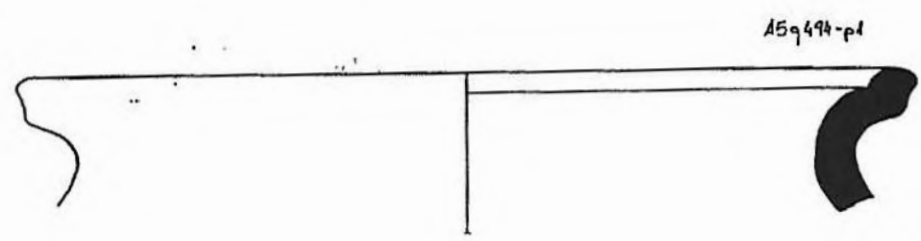

~~WS~~
AKSB12

Interior Grooved Jar

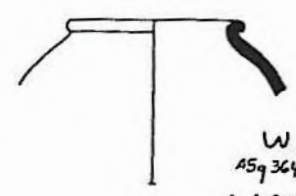

WS
AKSB11

Small Jar

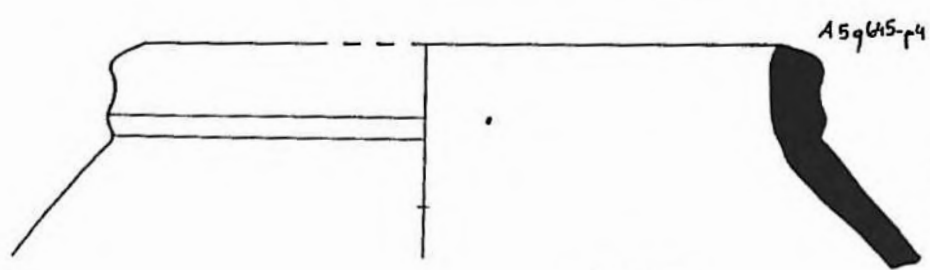

~~WS~~
AKSB12

Collared Rim

(23)

AK

WS Bowls

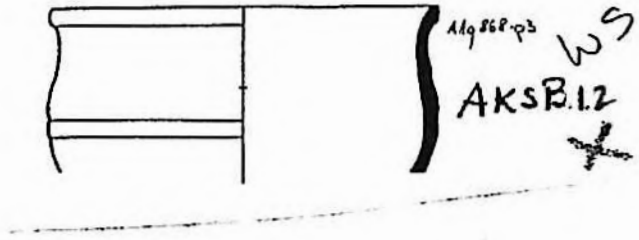

SMALL BOWL

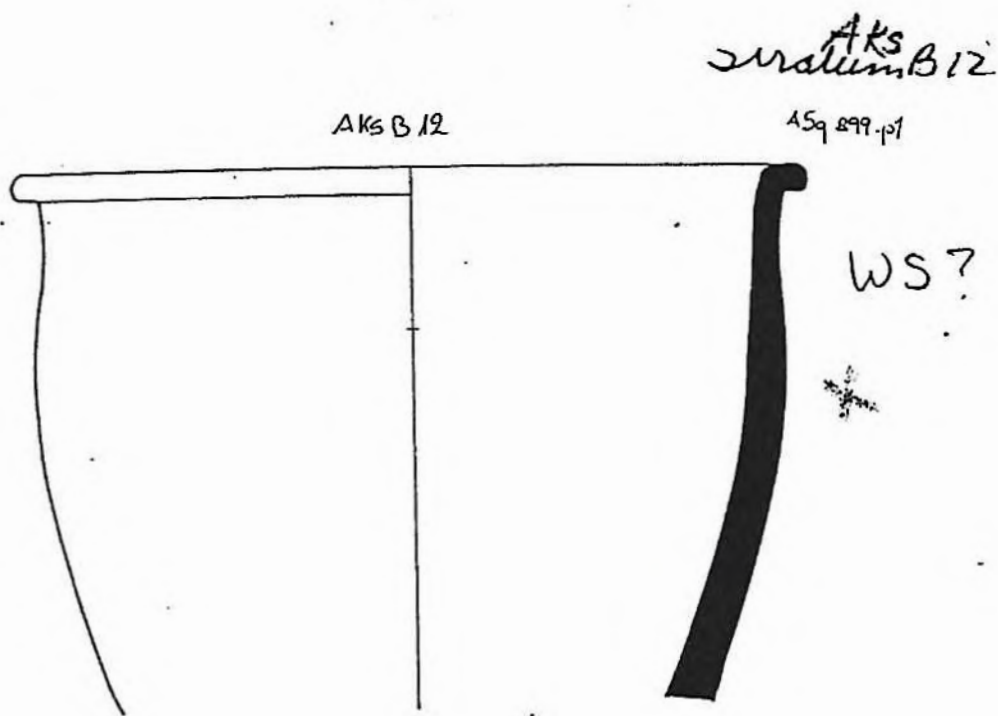

Deep Bowl

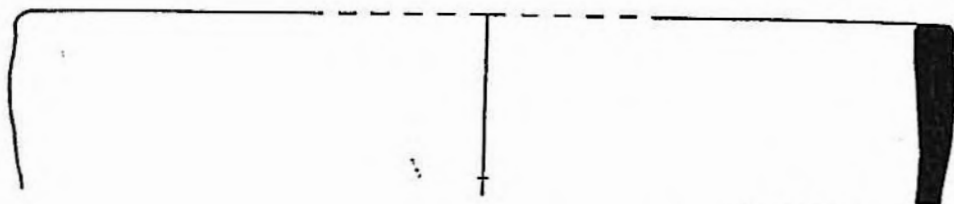

AKSB10 WS

WIDE BOWLS

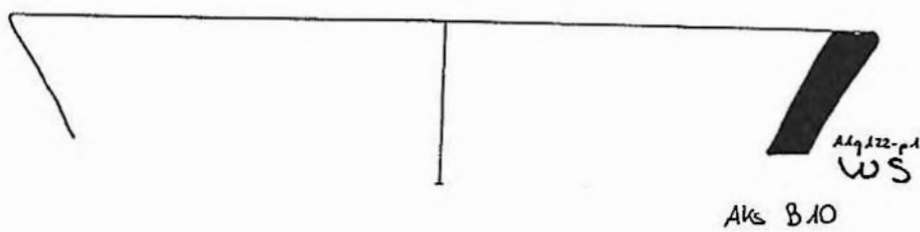

AKSB10

AK

I
JARS

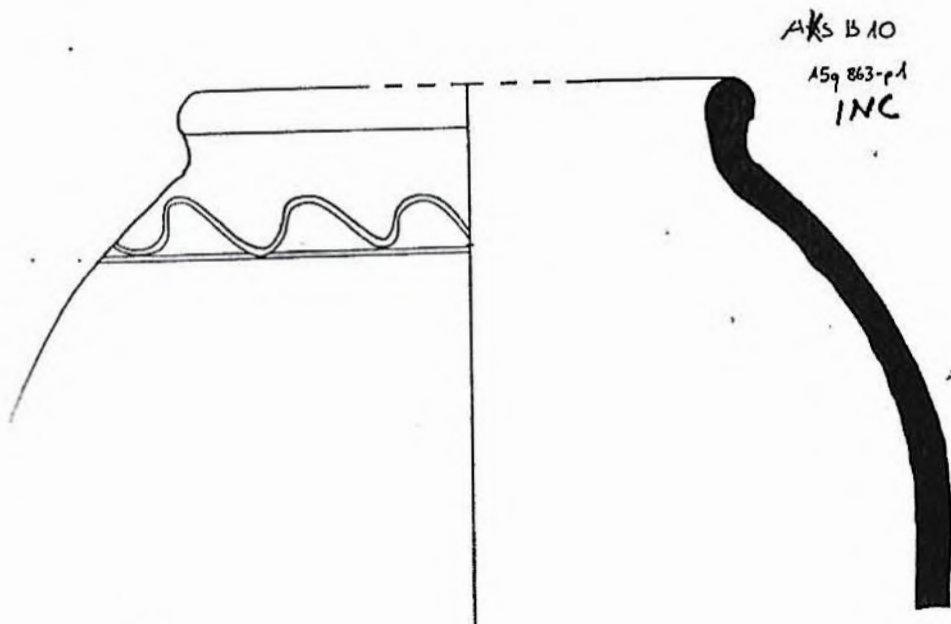
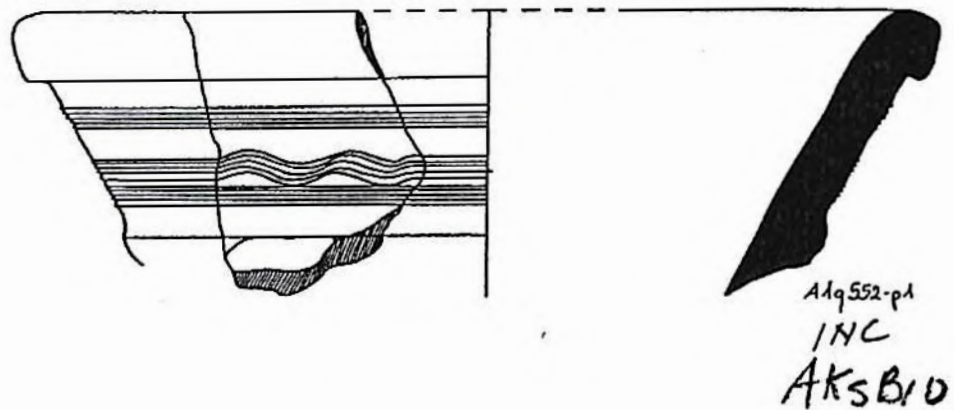
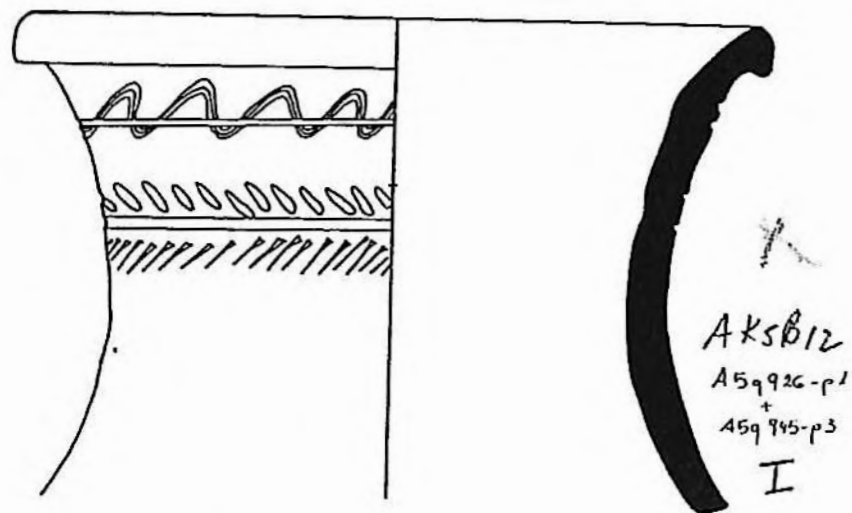
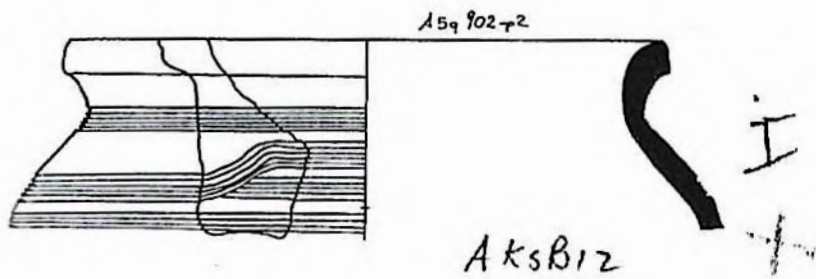

AK

I
Bowls

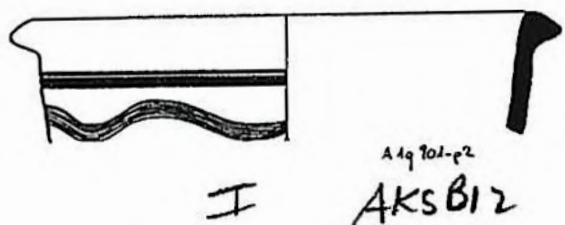

A19 701-p2
AKSB12

I

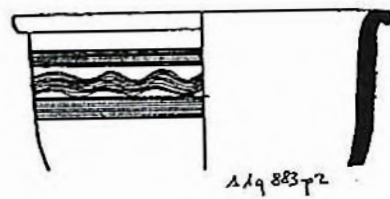

A19 883-p2

I
Calib
AKSB12

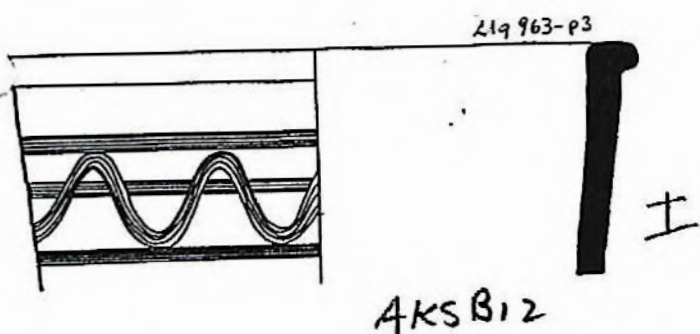

A19 963-p3

AKSB12

I

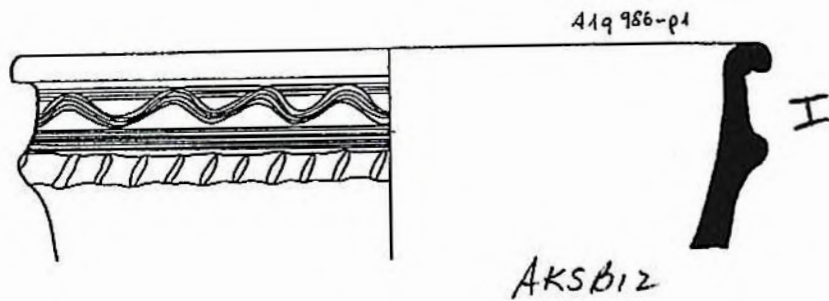

A19 986-p1

AKSB12

I

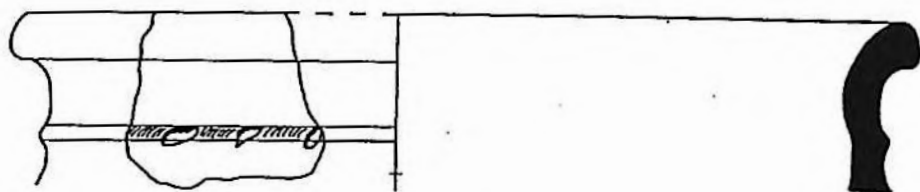

A59 399-p1
CH
AKSB11

STRAIGHT SIDED BOWLS

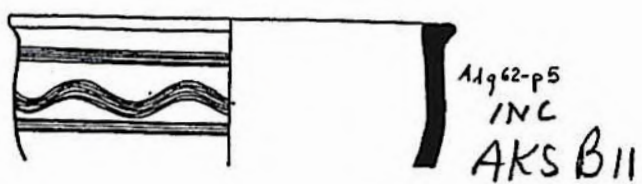

A19 62-p5
INC
AKSB11

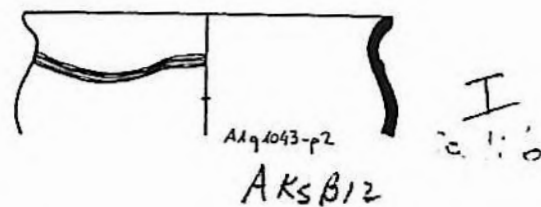

A19 1043-p2
AKSB12

I
Calib

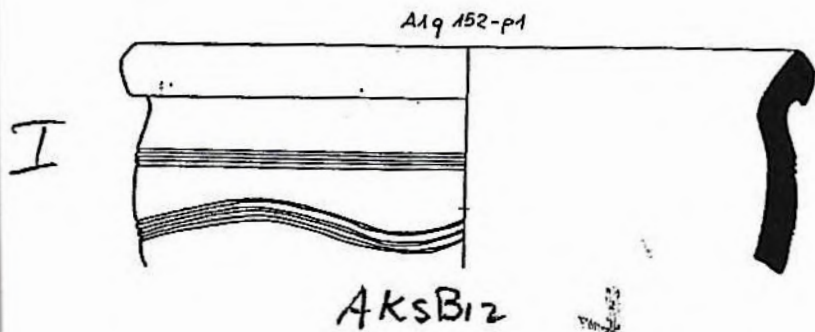

A19 152-p1

AKSB12

I

I

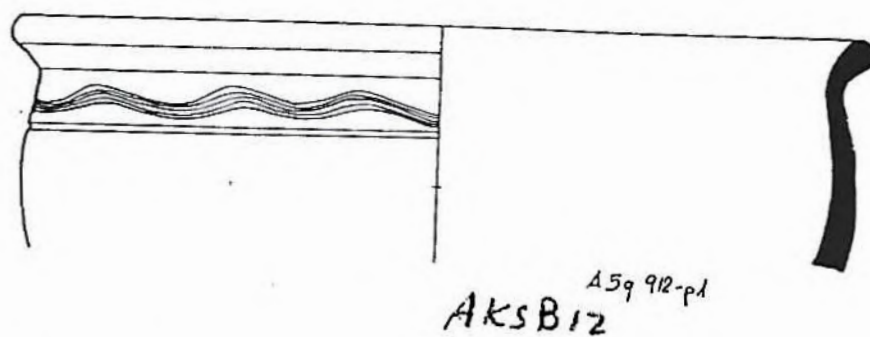

A59 912-p1
AKSB12

OTHER BOWLS

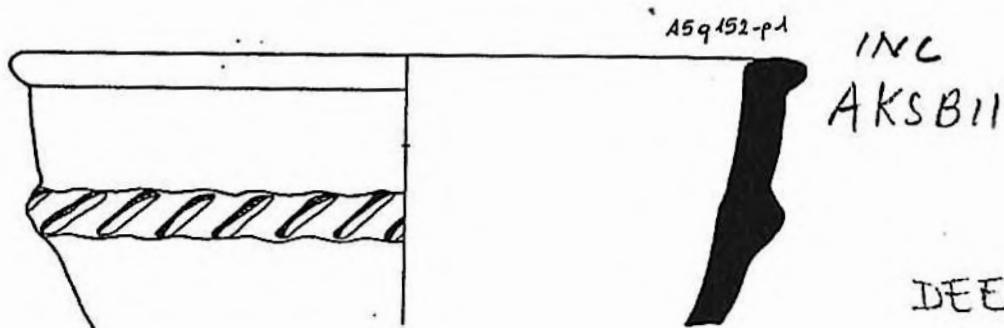

A59 152-p1

INC
AKSB11

DEEP BOWL

AK

I

STRAIGHT SIDE
BOWL

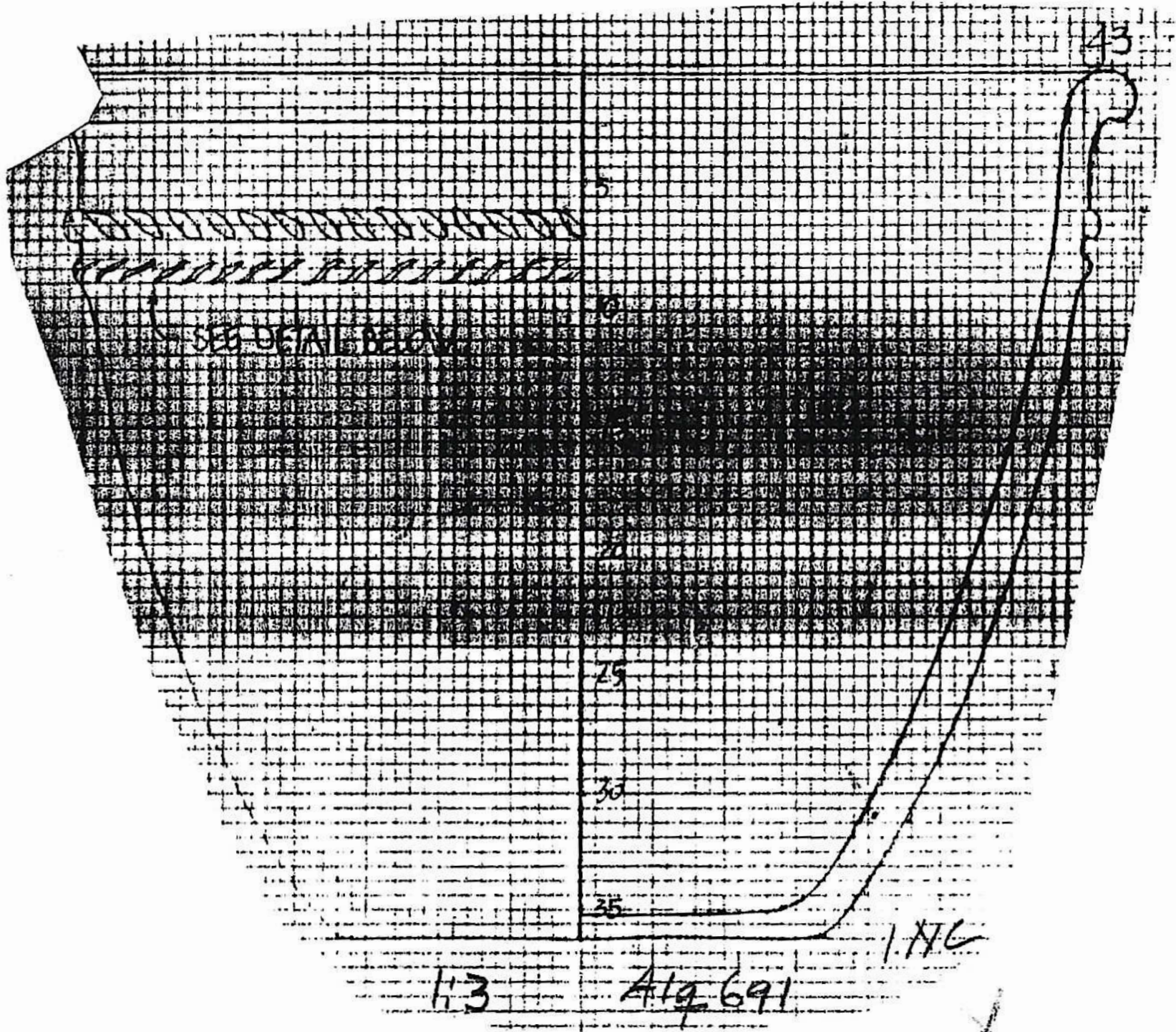

AK

M
BC
ETC

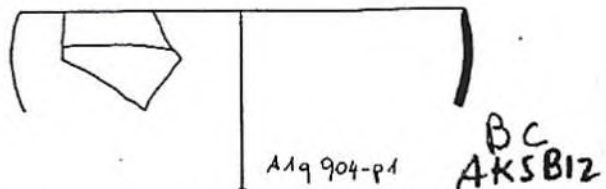

A19 904-p1
AKSB12 BC

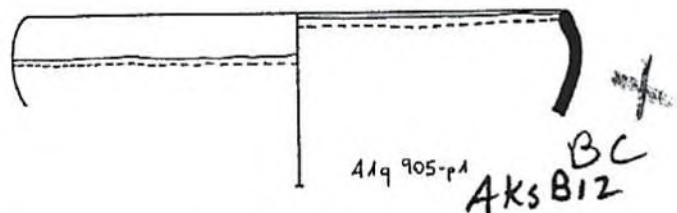

A19 905-p1
AKSB12 BC

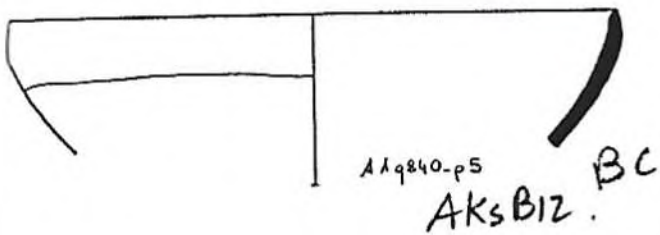

A19 840-p5
AKSB12 BC

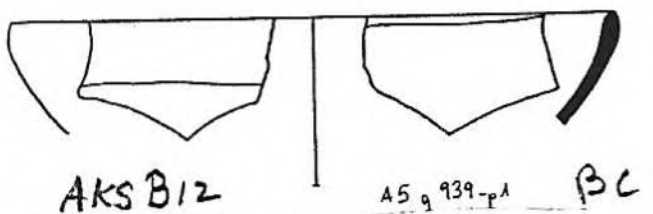

AKSB12
A5 9 939-p1 BC

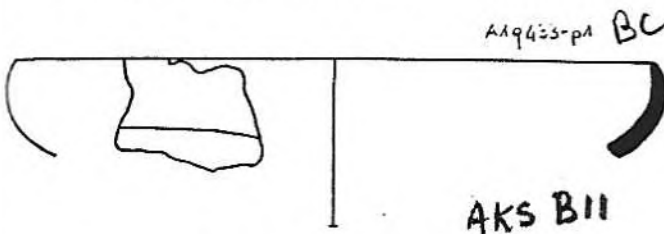

A19 433-p1 BC
AKSB12

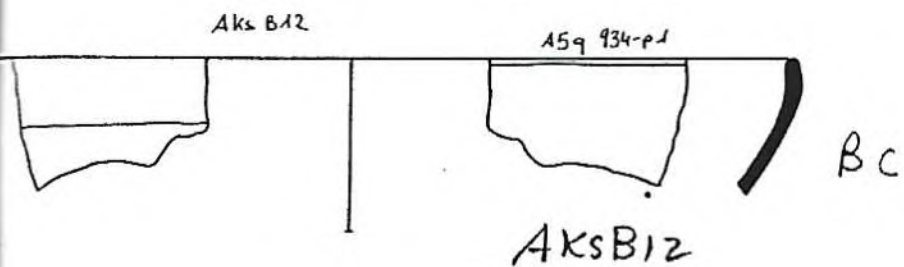

A5 9 934-p1 BC
AKSB12

BC

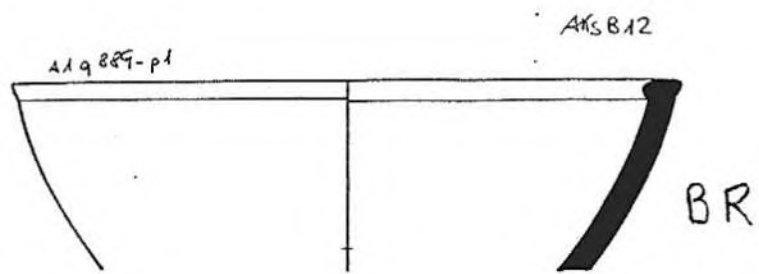

A19 889-p1
AKSB12 BR

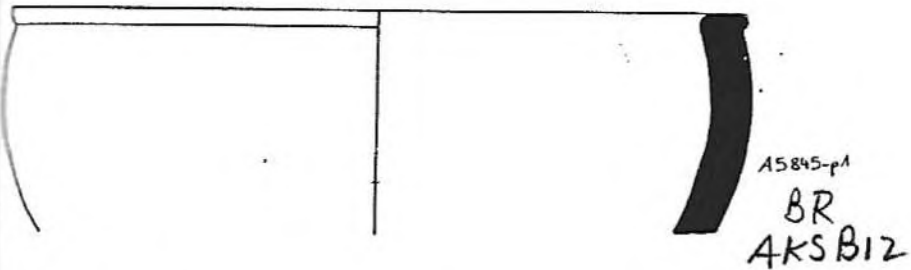

A5 845-p1
BR
AKSB12

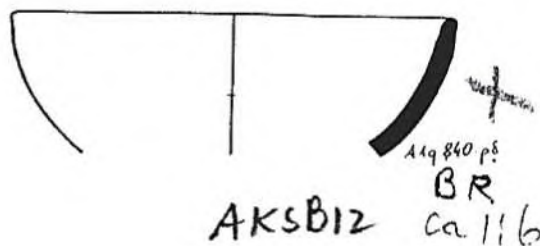

A19 840-p5
AKSB12 BR calib

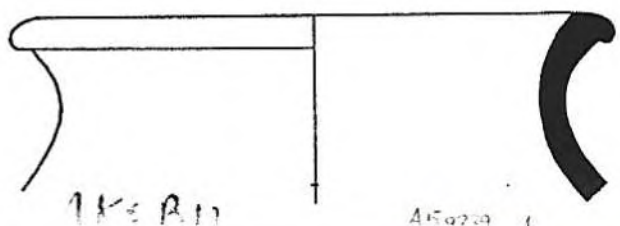

AKSB12
A5 9 934-p1

RD

98

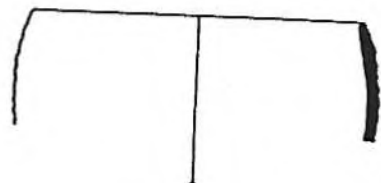

A19 840-p7 Metallic
AKSB12



A19 918-p1
AKSB12 Metallic

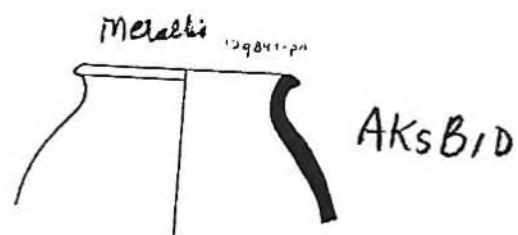

A5 9 645-p3
AKSB12 Metallic

M

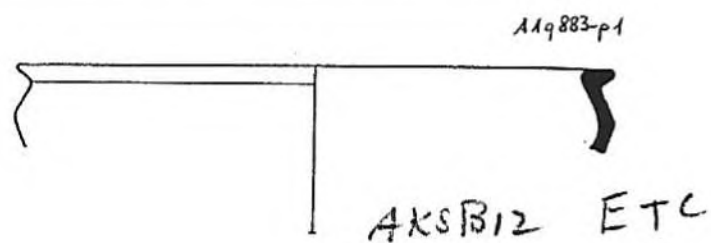

A19 883-p1
AKSB12 ETC

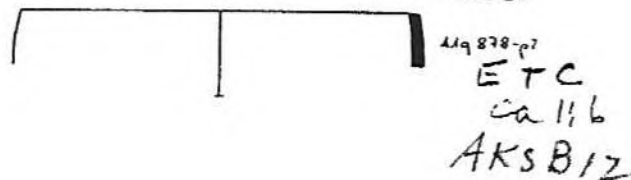

A19 878-p7
AKSB12 calib ETC

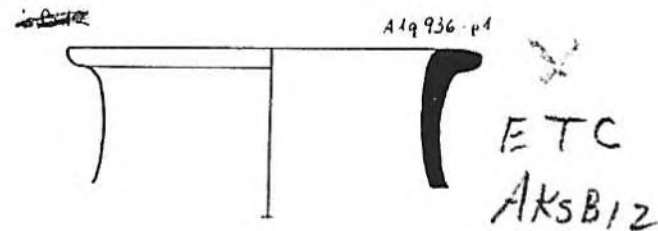

A19 936-p1
AKSB12 ETC

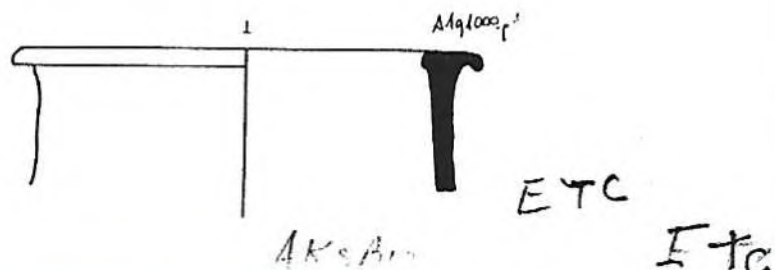

A19 1000-p1
AKSB12 ETC

AK

P, FP
R

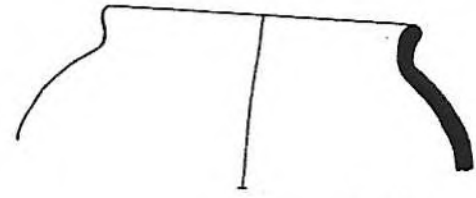

A19 963-p1
PF AKSB12
FP

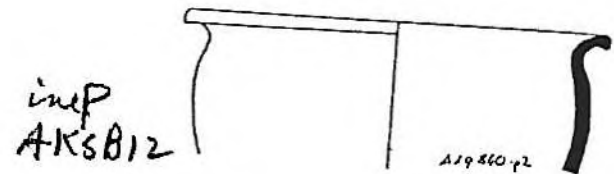

imp
AKSB12

A19 860-p2

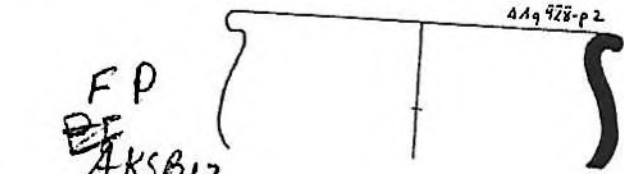

FP
PF
AKSB12
*

A19 928-p2

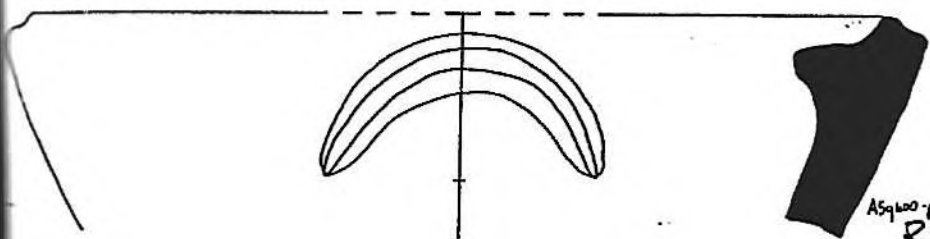

A59 400-p1
R
AKSB11

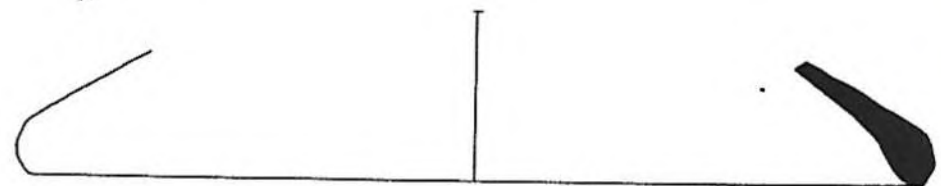

AKSB12 A19 927-p4
P Pebble tempered lid

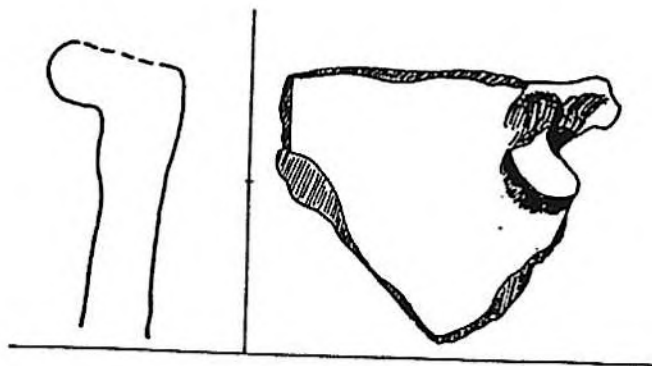

A19 62-p4
R
AKSB11

AKS B10

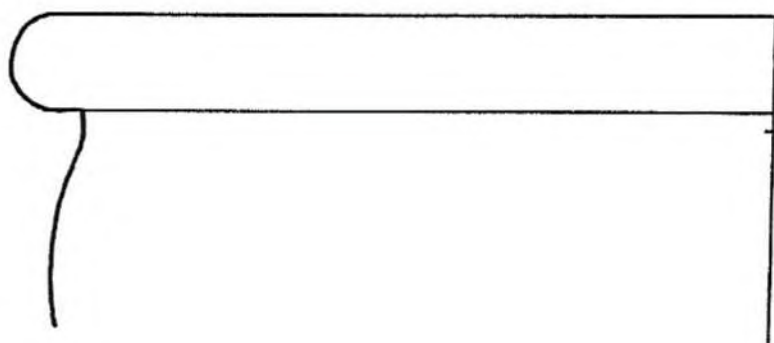

A59 852-p1
R
li6

AK

A5.4

PEBBLE
Tempered
COOKING POT

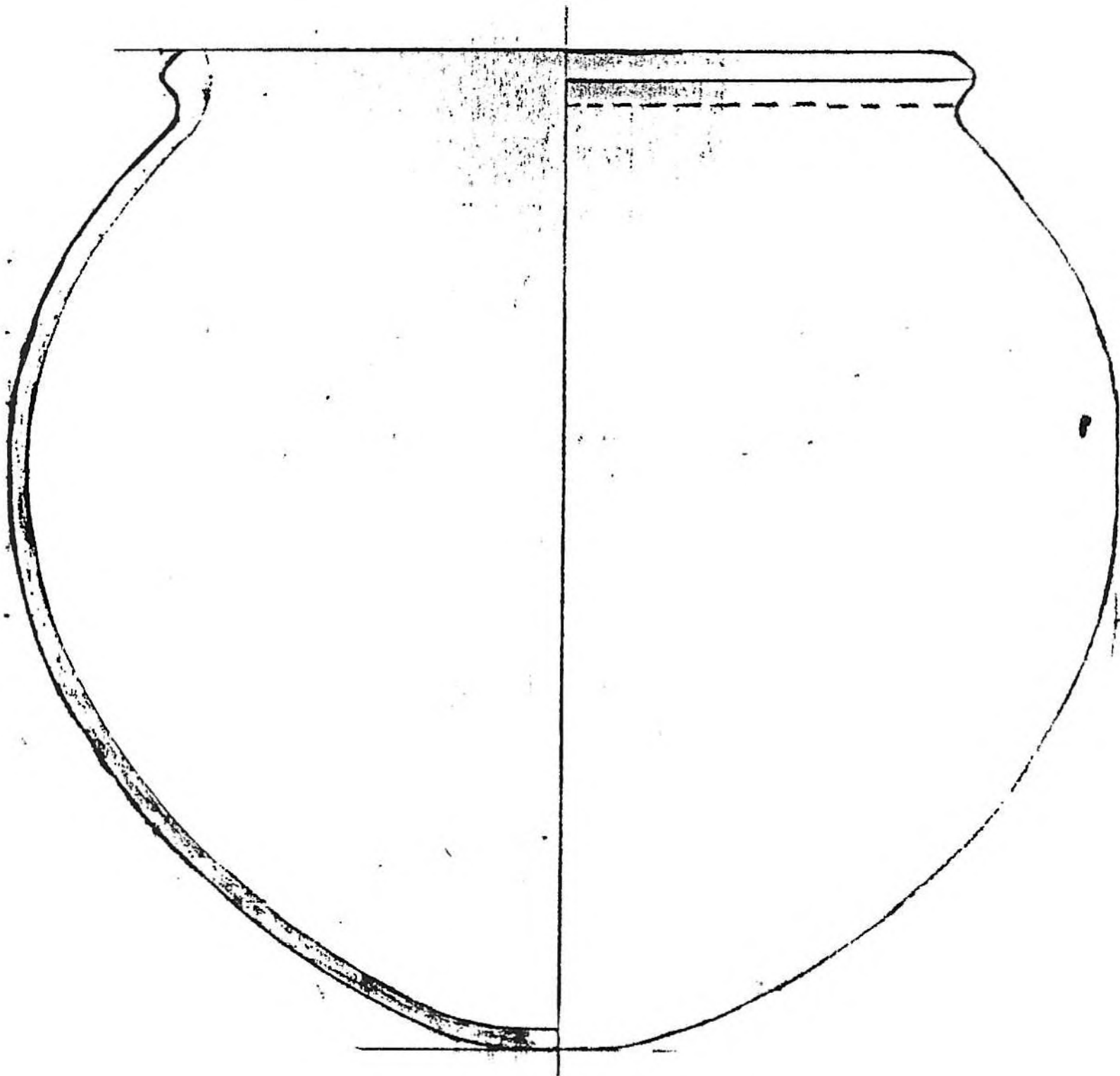

112

30

Appendix

Ceramic shapes
from the service quarter AK
of Palace AP

Marilyn Kelly-Buccellati
formatted by Diep Shoemaker

1997

**SHAPE CODES
FOR THIRD MILLENNIUM CERAMIC SHAPES
FROM AK BUILDING**

code shape category name

CHAFF TEMPERED WARE

srj simple rim jar
sqj square rim jar
nj necked jar
arj angled rim jar
hmj hole mouth jar
ssj straight sided jar
ilj interior ledge jar
crj collared rim jar
frj folded rim jar
ssb straight sided bowl
hmp hole mouth pot
cdb carinated deep bowl
cb carinated bowl
frb flat rim bowl
rpb rounded profile bowl
otb other bowls
op pot
pl platter
misc miscellaneous

FINE CHAFF TEMPERED

nb necked bottle
nj necked jar
hmj hole mouth jar
smj straight mouth jar
cc conical cup
str strainer
ssb straight sided bowl
db deep bowl
rpb rounded profile bowls
arb angled rim bowl
crb collared rim bowl
scb slightly curved bowl
cb carinated bowl
bit bowls interior thickened (rim)
frp flat rim plates

SIMPLE WARE

scj s curved jar
nj necked jar
sp spout
dlh double lug handle
cc conical cup
ob bowl
db deep bowl
cb carinated bowl
op pot
str strainer

WET SMOOTHED

nj necked jar
frj flaring rim jar
igj interior grooved jar
crj collared rim jar
sb small bowl
db deep bowl
wb wide bowl

INSCISED AND ROPE DECORATED

oj jar
ssb straight sided bowl
db deep bowl
otb other bowl
nj necked jar

METALLIC WARE

oj jar
nj necked jar
ob bowl

EARLY TRANSCAUCASIAN

oj jar
ob bowl
nj necked jar

BI-COLOR

oj jar
ob bowl

PEBBLE TEMPERED

op pot
ol lid

FINE PEBBLE TEMPERED

oj jar
ob bowl
ol lid

ROUGH

oj jar
ov vat

BRICK RED

oj jar
ob bowl

ch (chaff tempered pottery)

1. square rim jar sqj A8sA8a (A8q94-p3 f32)

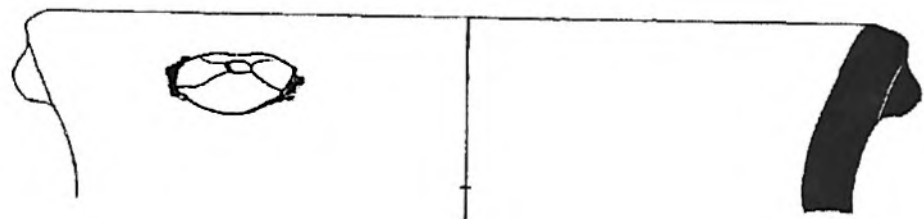

2. necked jar nj A8sA8 (A8q105-p4 f12)

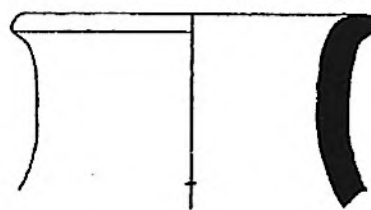

3. angled rim jar arj AKsB12 (A1q813-p2)

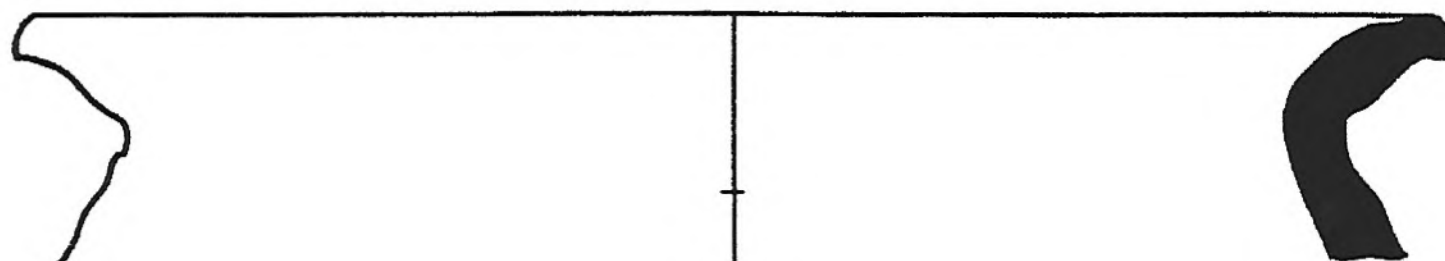

4. hole mouth jar hmj AKsB12 (A1q973-p1)

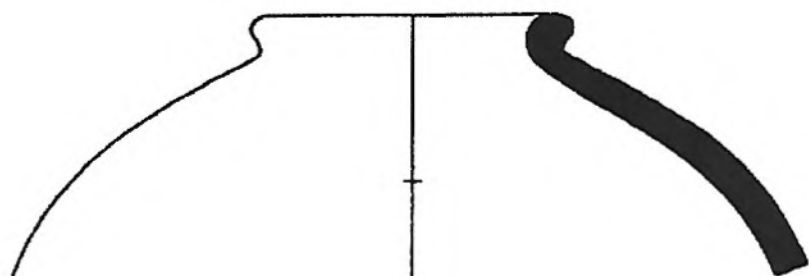

5. straight sided jar ssj A8sA8a (A8q89-p2 f32)

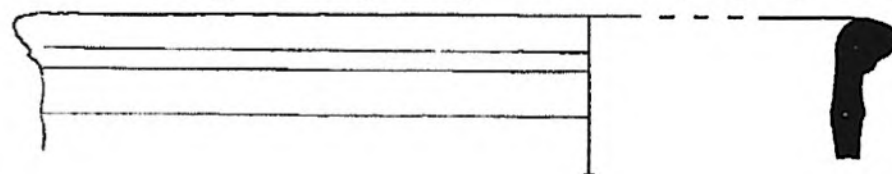

6. jar with interior ledge ilj AKsB12 (A5q494-p3)

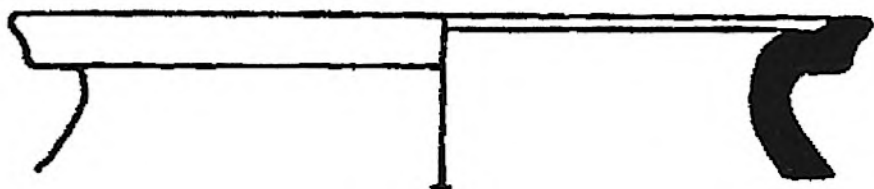

7. collared rim jar crj A8sA8a (A8q87-p2 f32)

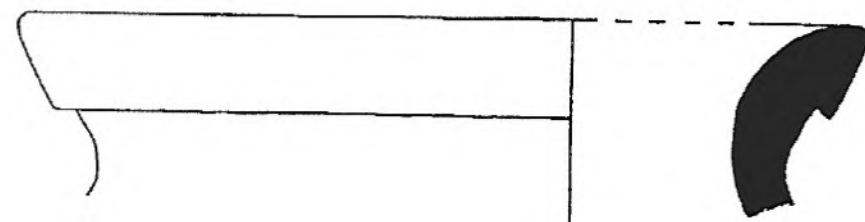

8. simple rim jar srj A8sA8a - (A8q84-p1 f32)

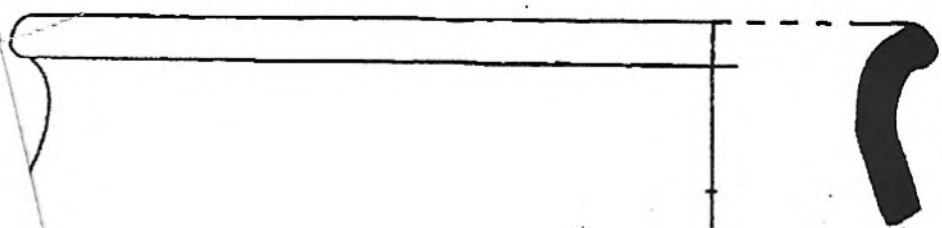

9. platter pl AKsB12 (A5q903-p3)

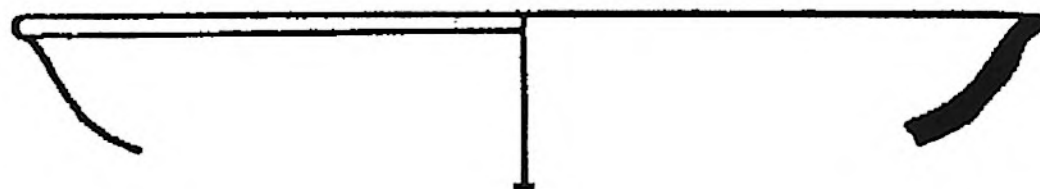

ch (chaff tempered pottery, cont.)

10. straight sided deep bowl ssb AKsB10 (A1q507-p1)

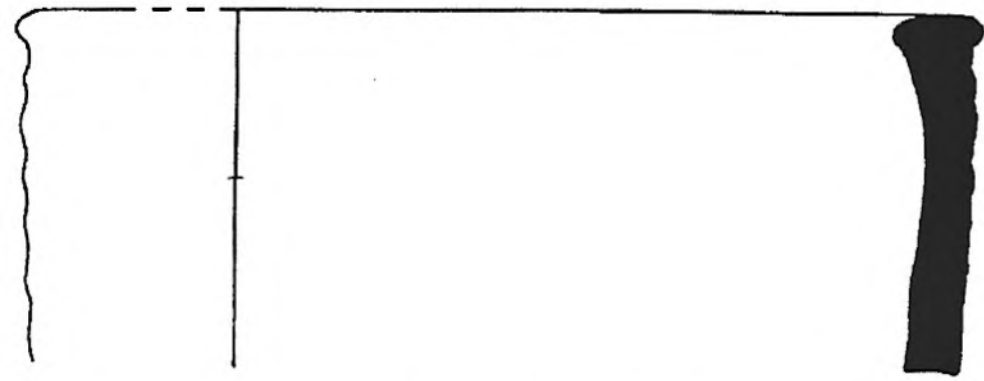

11. straight sided deep bowl with interior lug ssb AKsB12 (A1q929-p1)

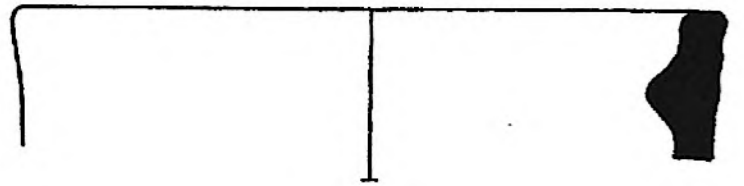

12. deep bowls with slight carinated bodies cdb AKsB12 (A1q905-p3)

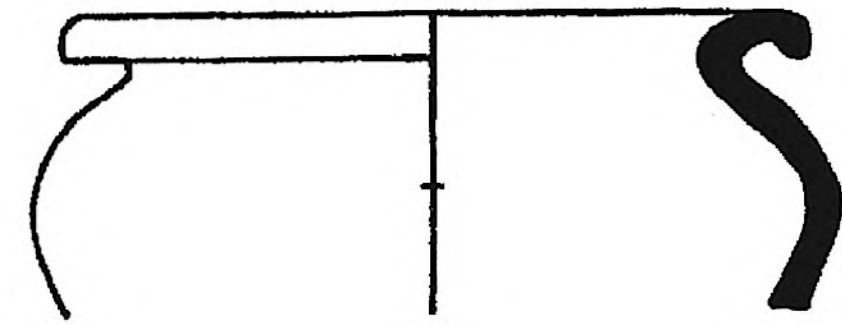

13. carinated bowl cb AKsB12 (A5q704-p1)

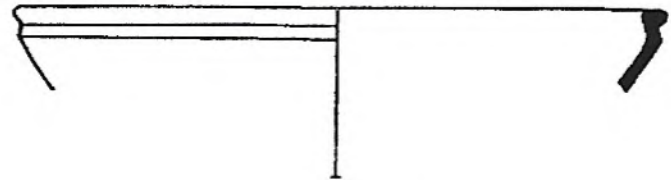

14. rounded profile bowl rpb AKsB10 (A5q605-p)

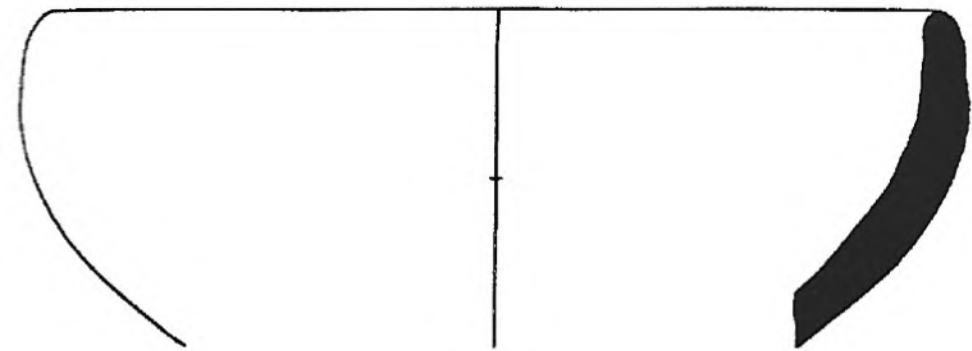

15. other bowl otb AKsB12 (A1q862-p2)

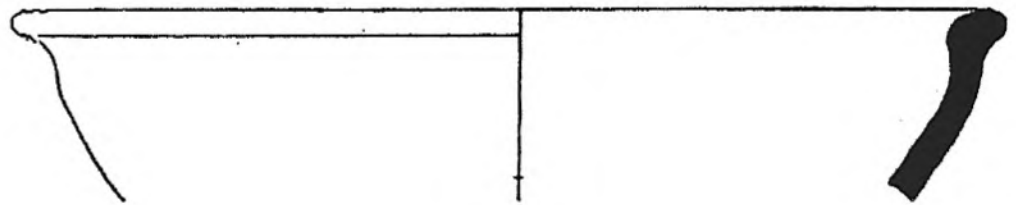

16. flat rim bowl frb AKsB11 (A5q243-p2)

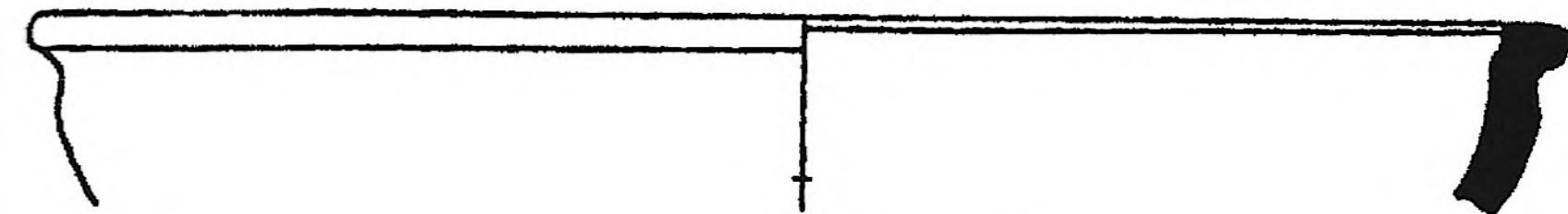

fc (fine chaff ware)

17. necked jar nj AKsB12 (A1q928-p3)
SCALE= 1:2

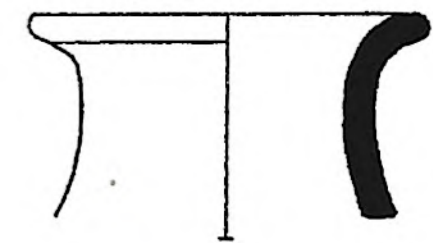

18. straight mouth jar smj A8sA8 (A8q109-p6 f12)

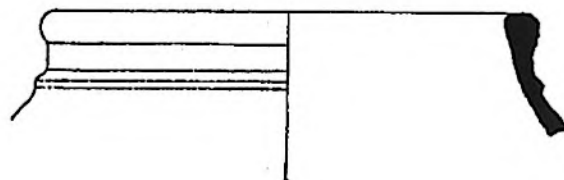

19. conical cup cc AKsB12 (A1i232)

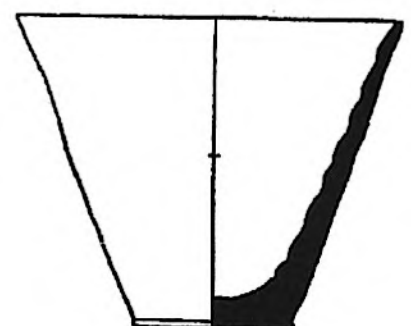

fc (fine chaff ware, cont.)

20. deep bowl db AKsB12 (A1q931-p3)

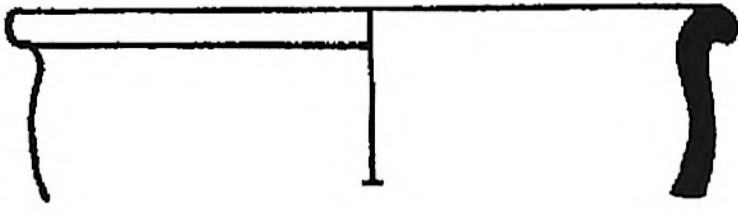

21. rounded profile bowl rpb AKsB12 (A5q678-p1)

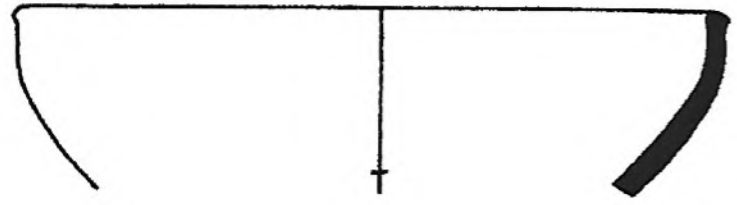

22. collared rim bowl crb AKsB12 (A1q503-p1)

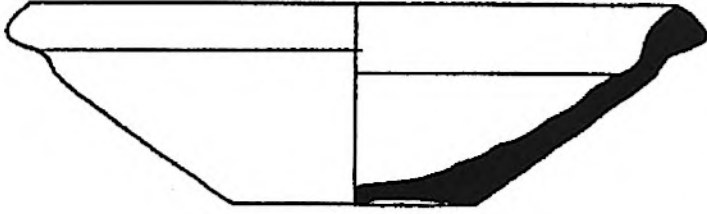

23. slightly curved rim bowl scb AKsB12 (A5q494-p2)

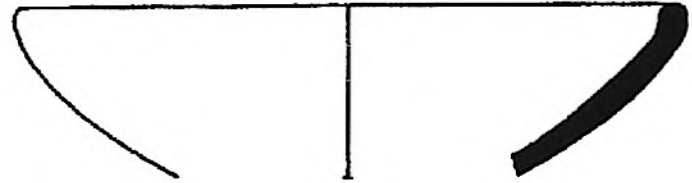

24. angled rim bowl arb AKsB12 (A5q951-p1)



25. carinated bowl cb AKsB12 (A1q733-p3)

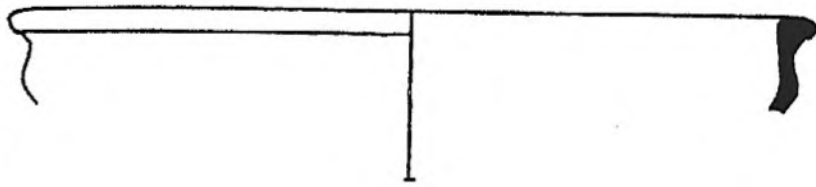

26. bowl with interior thickened rim bit
AKsB12 (A1q818-p1)

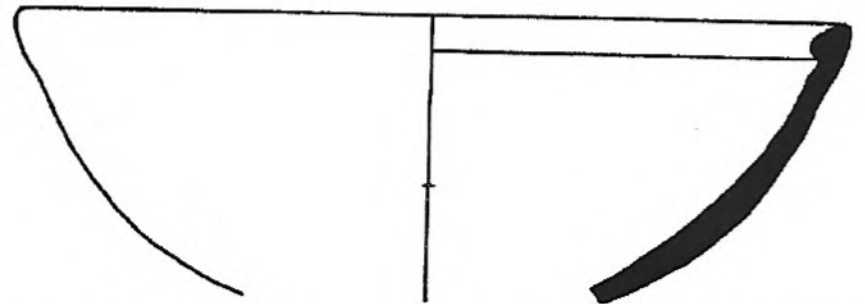

27. straight sided deep bowl ssb AKsB11 (A1q62-p1)

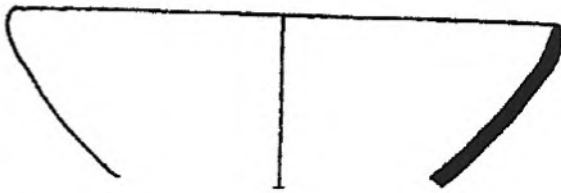

28. flat rim plate frp AKsB12 (A1q818-p2)

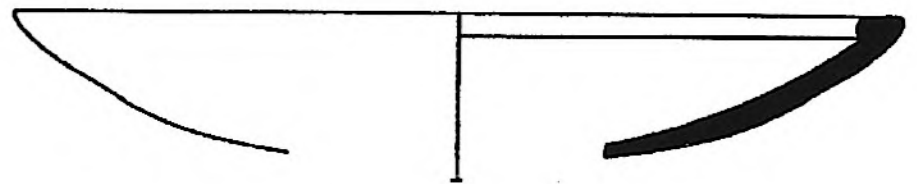

s (simple ware)

29. high neck jar nj AKsB12 (A5q793-p1)
SCALE= 1:2

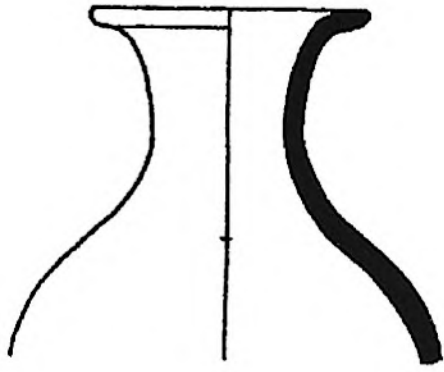

30. small jar with s-curved profile scj
AKsB12 (A1q835-p3)

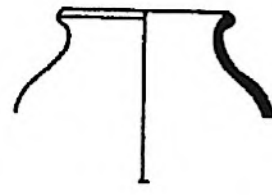

31. conical cup cc
AKsB12 (A5q705-p1)

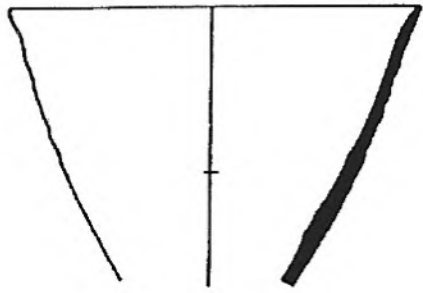

32. bowl ob
AKB11 (A1q1044-p1)

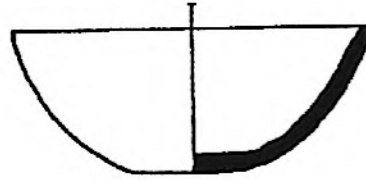

33. pot op
AKsB12 (A5q939-p2&3)

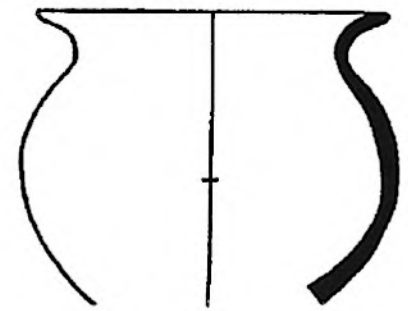

34. deep bowl db AKsB12 (A5q642-p1)

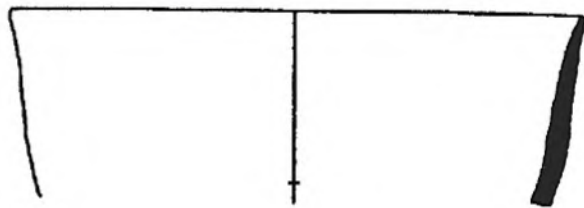

35. carinated bowl cb AKsB12 (A5q945-p4)

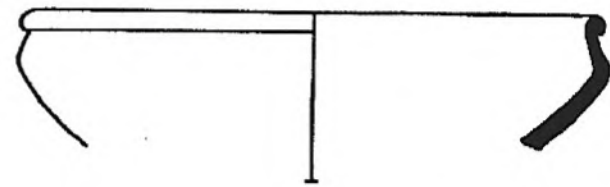

ws (wet smoothed ware)

36. necked jar nj AKsB12 (A1q866-p2)

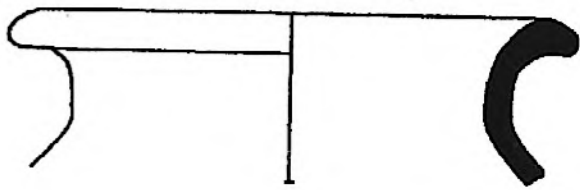

37. interior grooved jar igj AKsB12 (A5q494-p1)

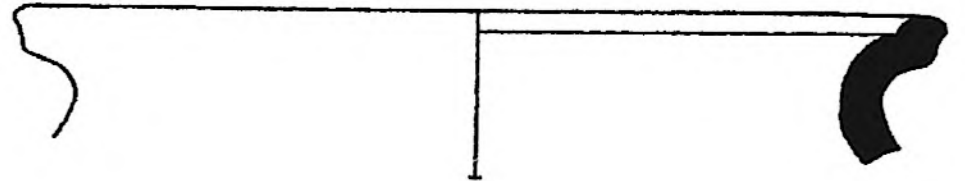

38. flaring rim jar frj AKsB12 (A5q901-p2)

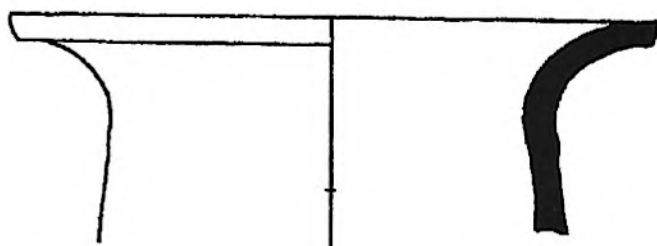

39. collared rim jar crj AKsB12 (A5q645-p4)

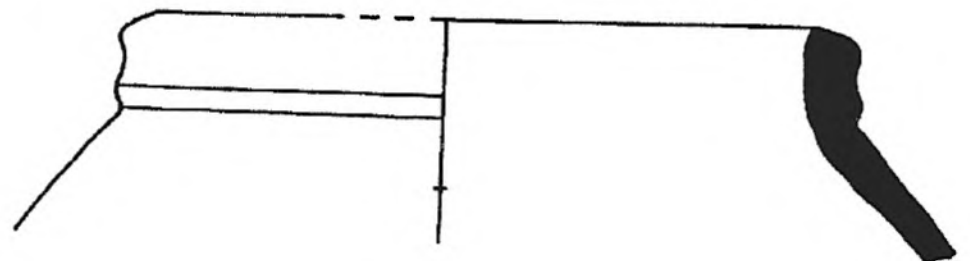

ws (wet smoothed ware, cont.)

40. small bowl sb AKsB12 (A1q868-p3)

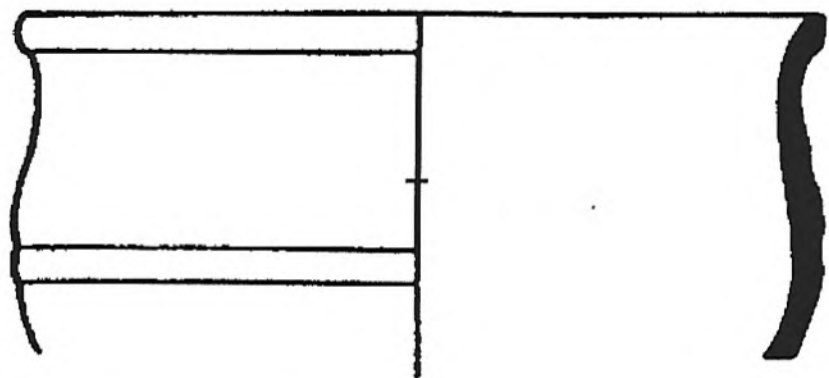

41. wide bowl wb AKsB10 (A1q291-p1)

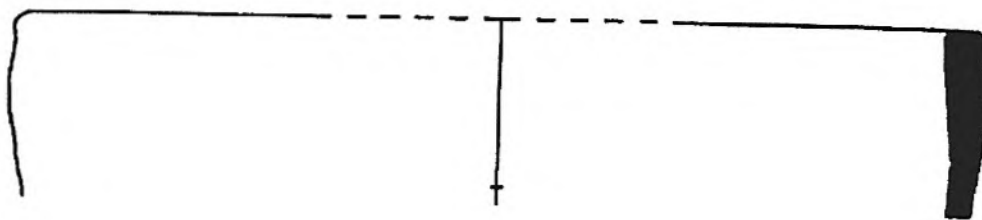

42. deep bowl db AKsB12 (A5q899-p1)

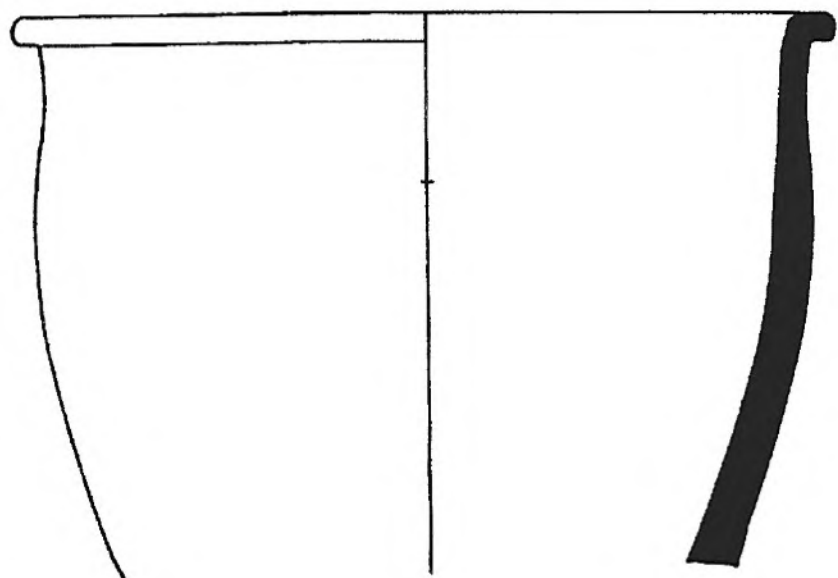

3

43. jar oj AKsB12 (A5q902-p2)

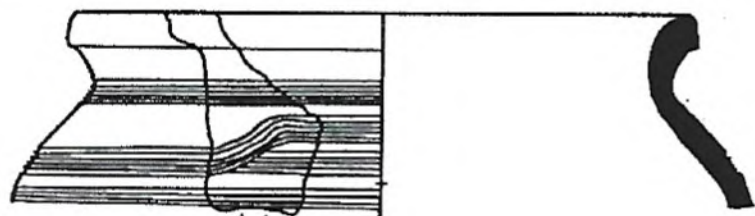

i (incised ware)

44. necked jar nj AKsB12 (A5q926-p1 & A5q945-p3)

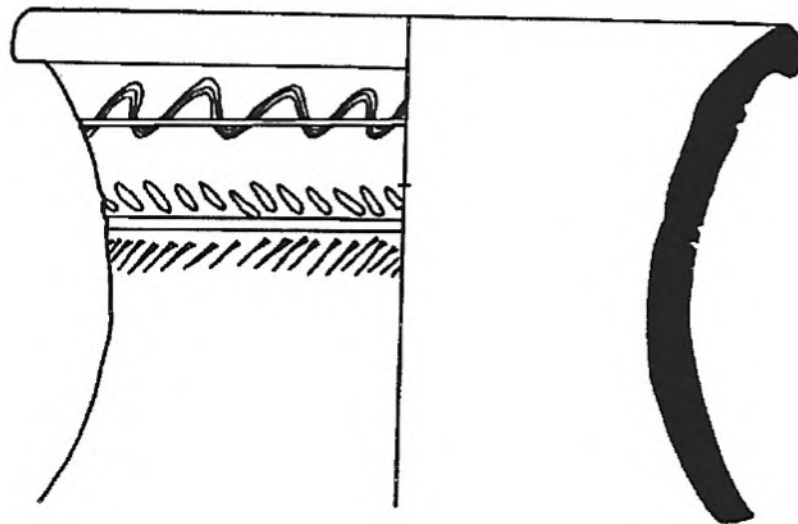

i (incised ware, cont.)

45. other bowls otb AKsB12 (A1q152-p1)

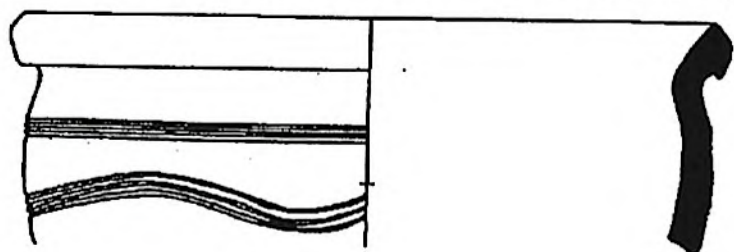

46. deep bowl db Alq691
SCALE= 1:6

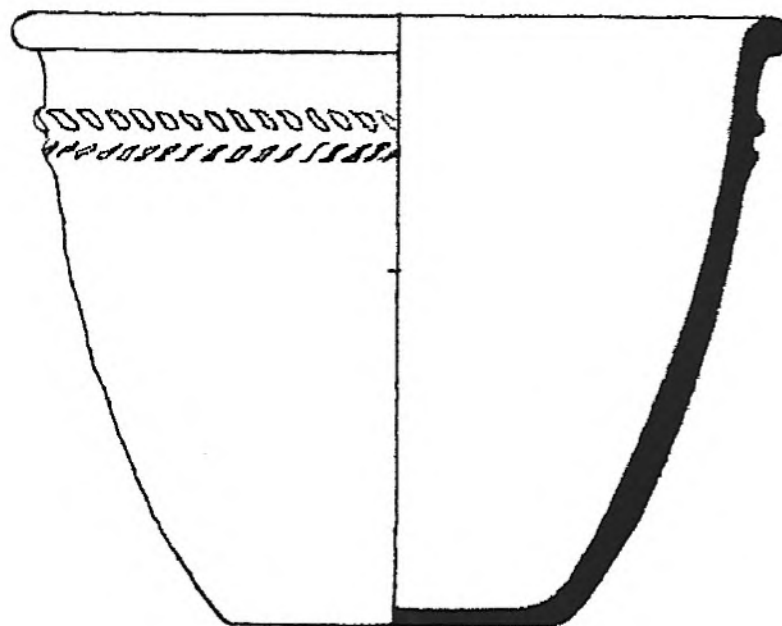

bc (bi-color ware)

47 bowl ob AKsB12 (A1q905-p1)

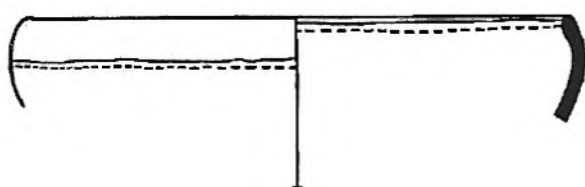

br (brick red ware)

48 bowl ob AKsB12 (A1q840-p8)

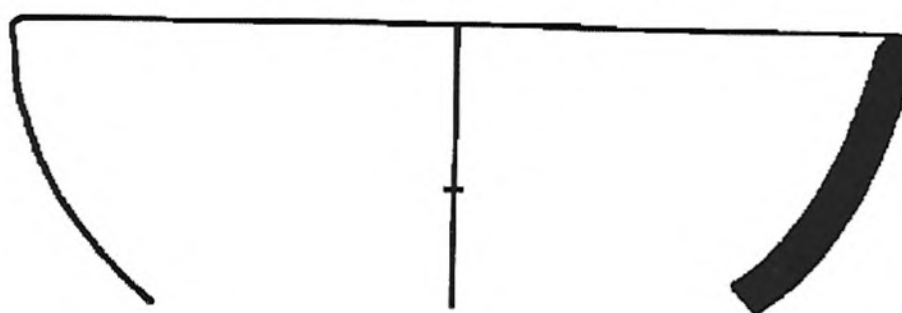

m (metallic ware)

49 necked jar nj AKsB12 (A5q645-p3)

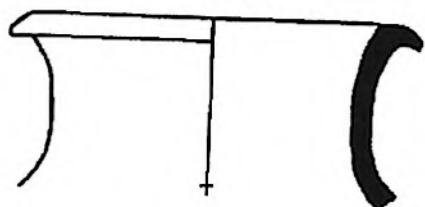

etc (early trans-caucasian ware)

50. necked jar nj AKsB12 (A1q936-p1)

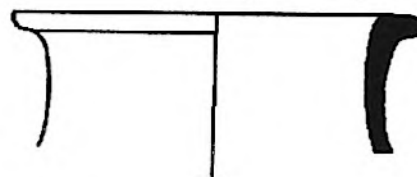

r (rough ware)

51. jar oj AKsB10 (A5q852-p1)
SCALE= 1:6

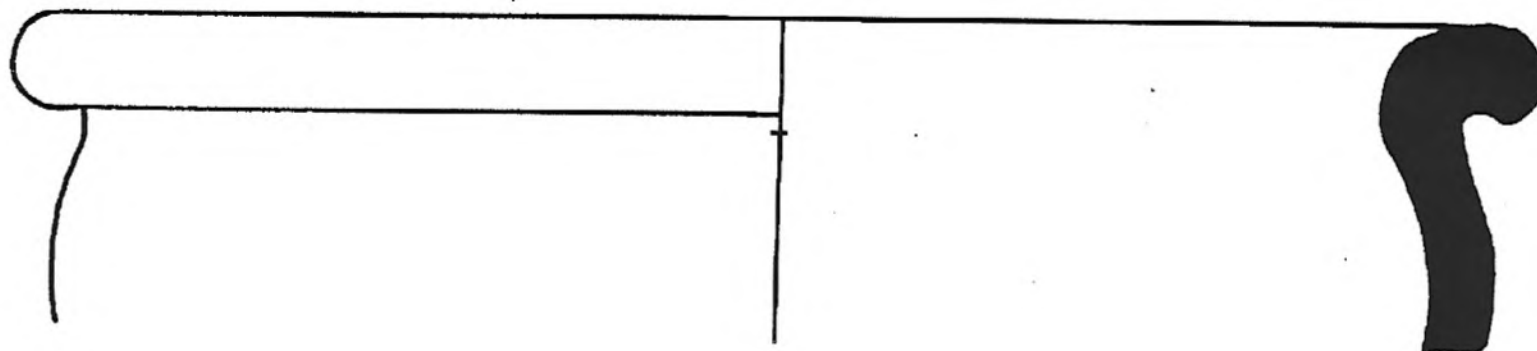

fp (fine pebble tempered ware)

p (pebble tempered ware)

52. bowl ob AKsB12 (A1q928-p2)

53. cooking pot op MZ7A5.4
SCALE= 1:4

